

Wireless OFDMA PHY Layer

IEEE 802.16-2004

IEEE 802.16e-2005

Permission is granted to copy, distribute and/or modify this document under the terms of the GNU Free Documentation License, Version 1.3 or any later version published by the Free Software Foundation; with no Invariant Sections, no Front-Cover Texts, and no Back-Cover Texts. A copy of the license is attached entitled "GNU Free Documentation License".

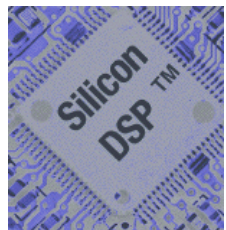

Silicon DSP Corporation

© 2007 Silicon DSP Corporation, All Rights Reserved

IEEE 802.16

Date: December 2001

- **Original Fixed Wireless Broadband Air Interface for 10 – 66 GHz**
- **Line-of-sight only, Point-to-Multipoint Applications**

IEEE 802.16a

Date: January 2003

- **Extension for 2-11 GHz**
- **Targeted for non line of sight, Point-to-Multi-Point applications like “last mile” broadband access**
- **OFDM**
- **OFDMA**

Point to Multi-Point Links





IEEE 802.16d

IEEE 802.16-2004

- **802.16 Revision PAR for 802.16 & 802.16a to add WiMAX System Profiles and Errata for 2-11 GHz in support of 802.16e requirements**

PAR : Project Authorization Request

WiMAX: Worldwide Interoperability for Microwave Access

IEEE 802.16e-2005

Date: October 2005

- **Amendment for Mobile wireless broadband up to vehicular speeds in licensed bands from 2-6 GHz**
- **Enables roaming for portable clients (laptops) within & between service areas (Handover)**



Orthogonal Frequency-Division Multiple Access

Original Work

Sari H., and Karam, G., .*Orthogonal Frequency-Division Multiple Access and its Application to CATV Networks*,. European Transactions on Telecommunications (ETT), vol. 9, no. 6, pp. 507-516, Nov.. Dec. 1998.

Krista S. Jacobsen, John A.C. Bingham and John M. Cioffi ,*Synchronized DMT for Multipoint-to-point Communications on HFC Networks*, IEEE Global Telecommunications Conference, 1995

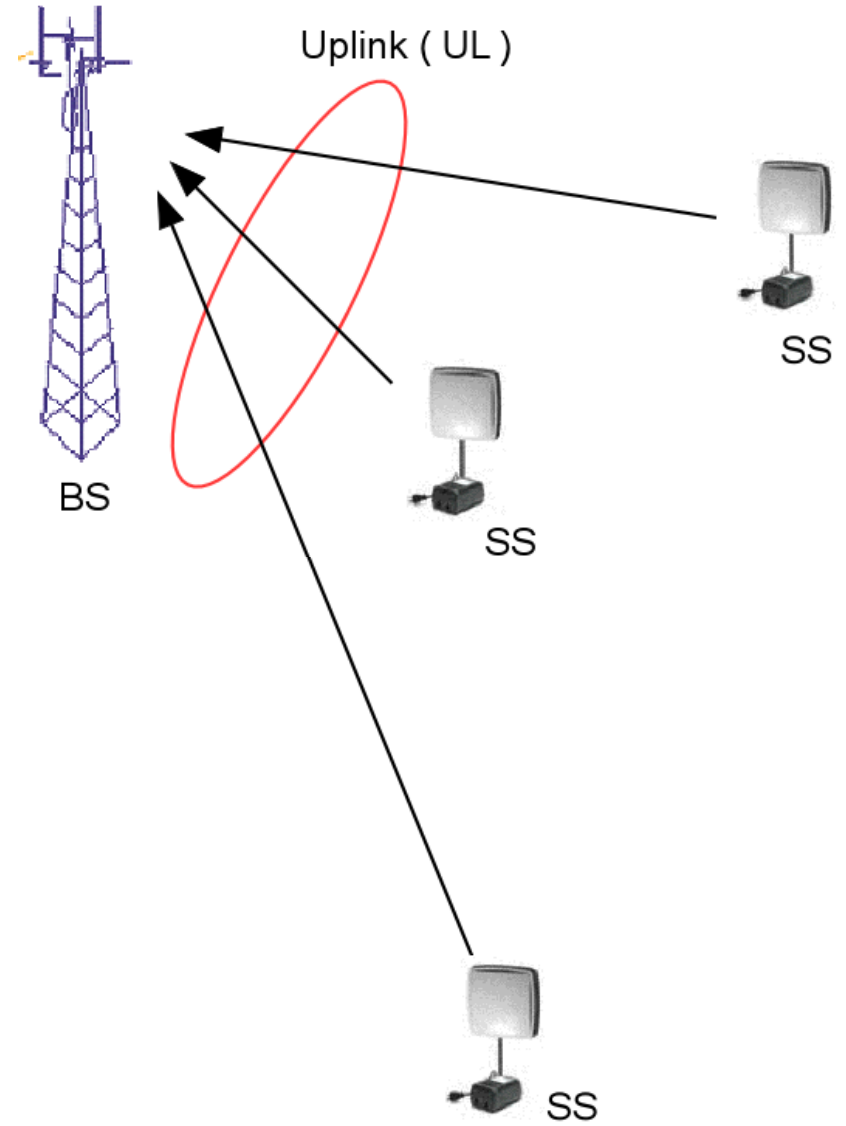
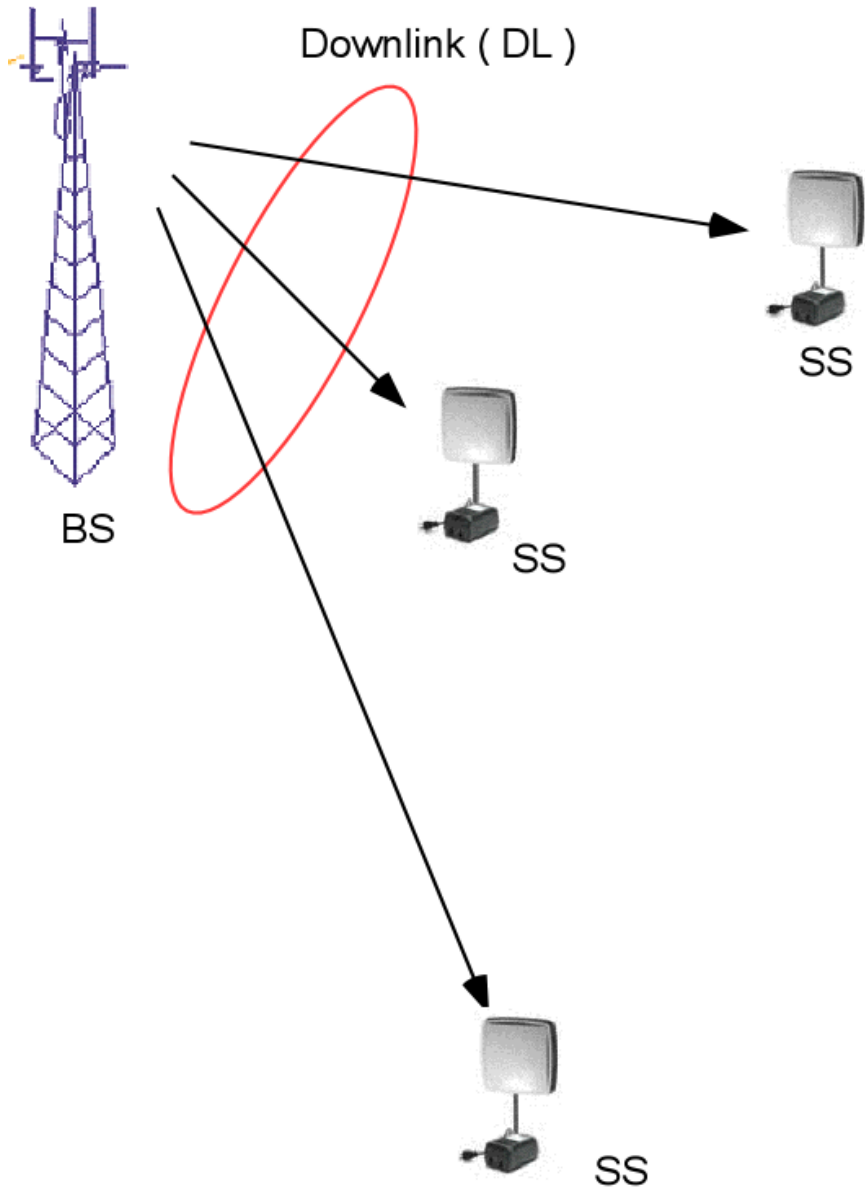

Synchronization

16a OFDMA

8.5.10.1.2 SS synchronization

For any duplexing, all SSs shall acquire and adjust their timing such that all uplink OFDM symbols arrive time coincident at the Base-Station to a accuracy of +/- .25% of the minimum guard-interval or better.

OFDMA Concepts

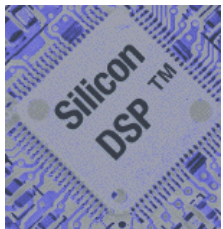

Silicon DSP Corporation

© 2007 Silicon DSP Corporation, All Rights Reserved

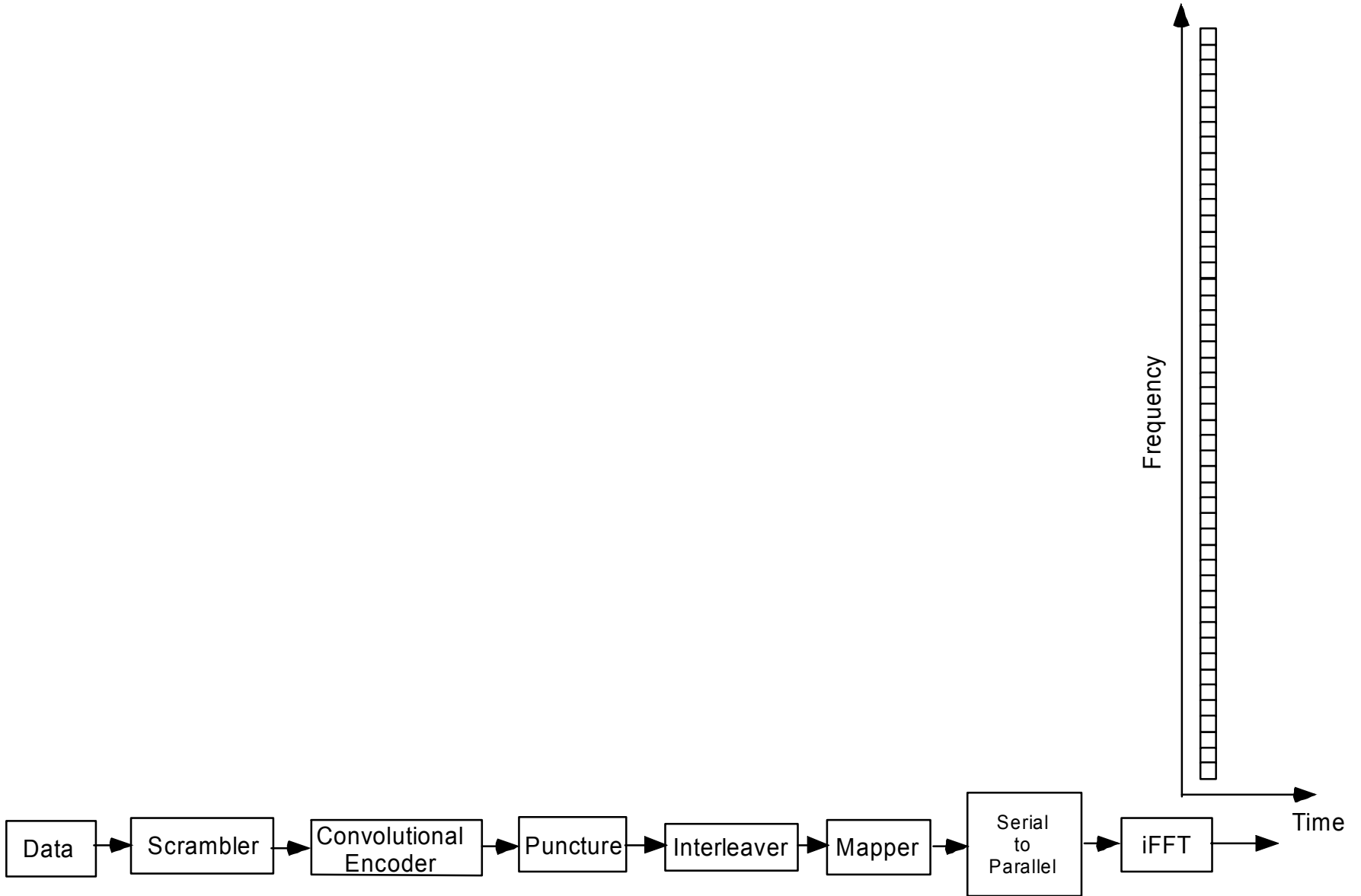

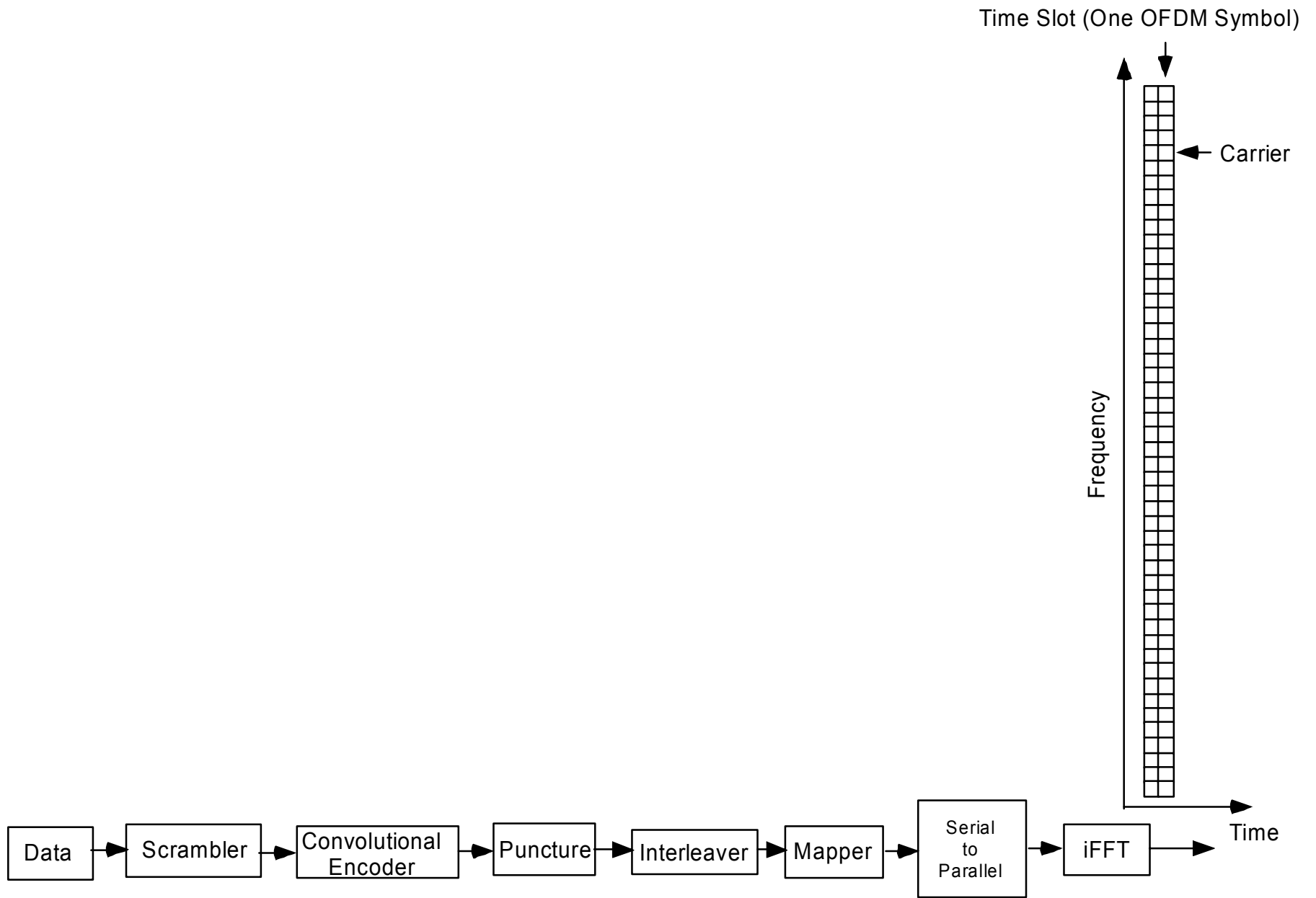

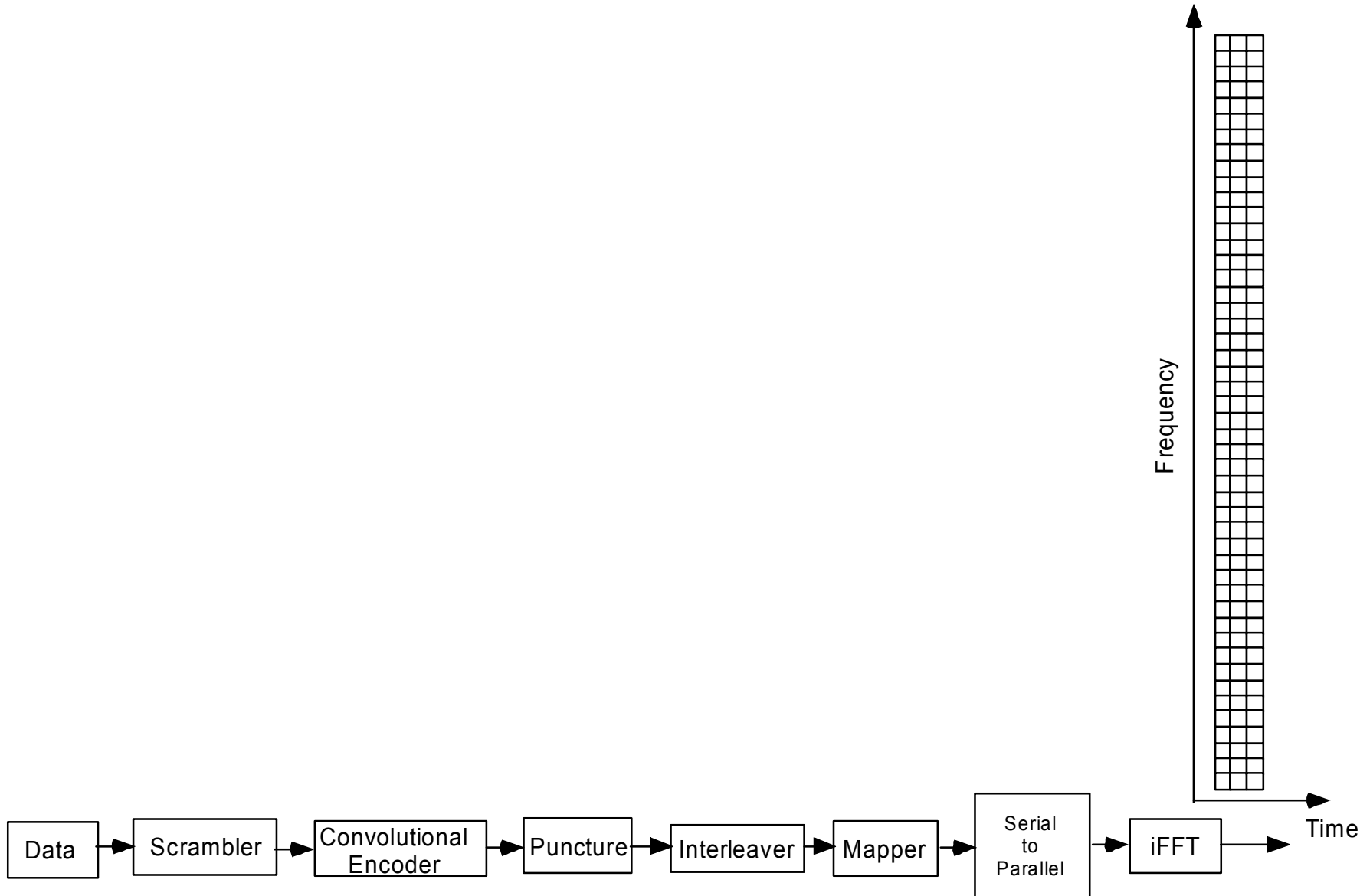

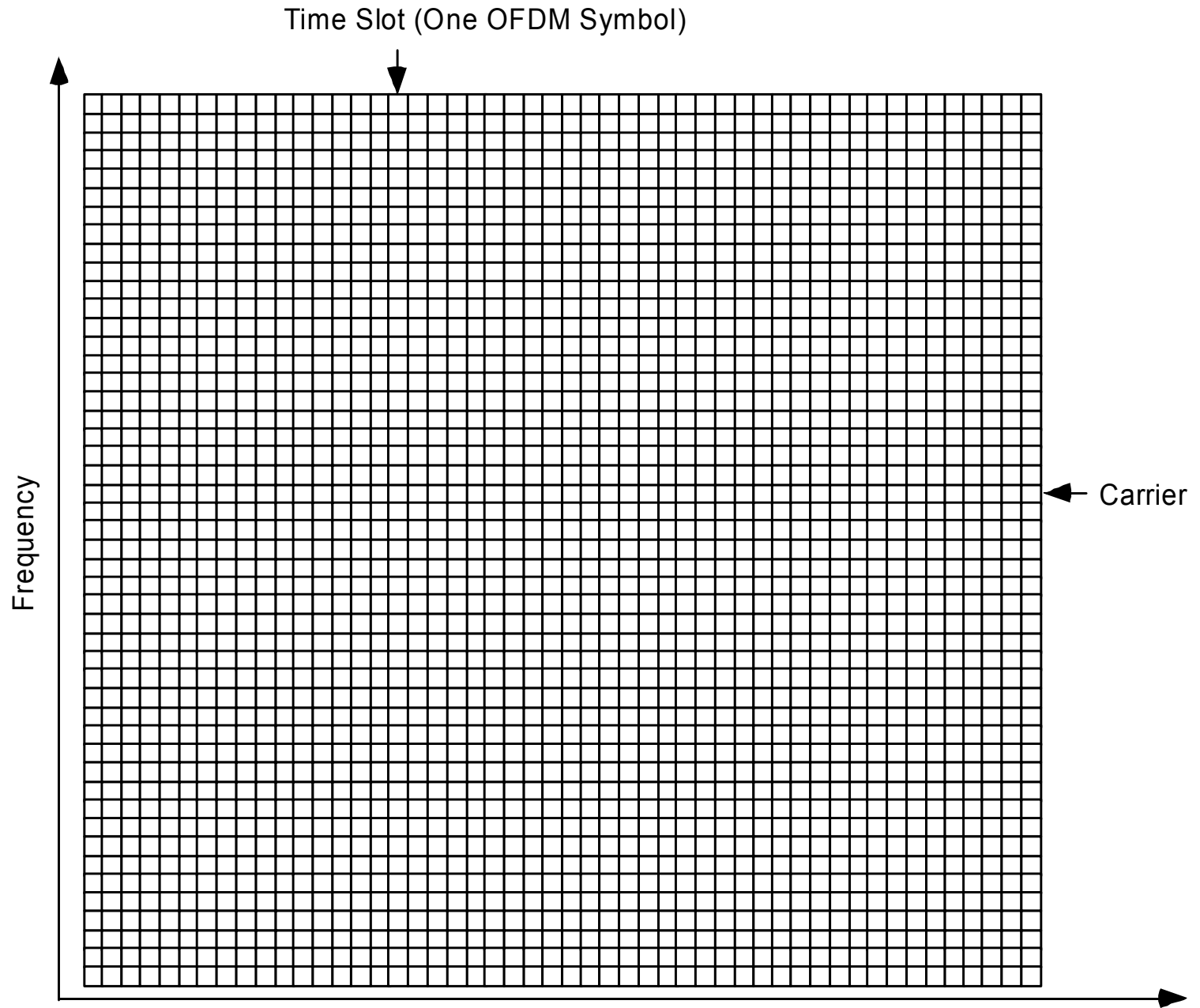

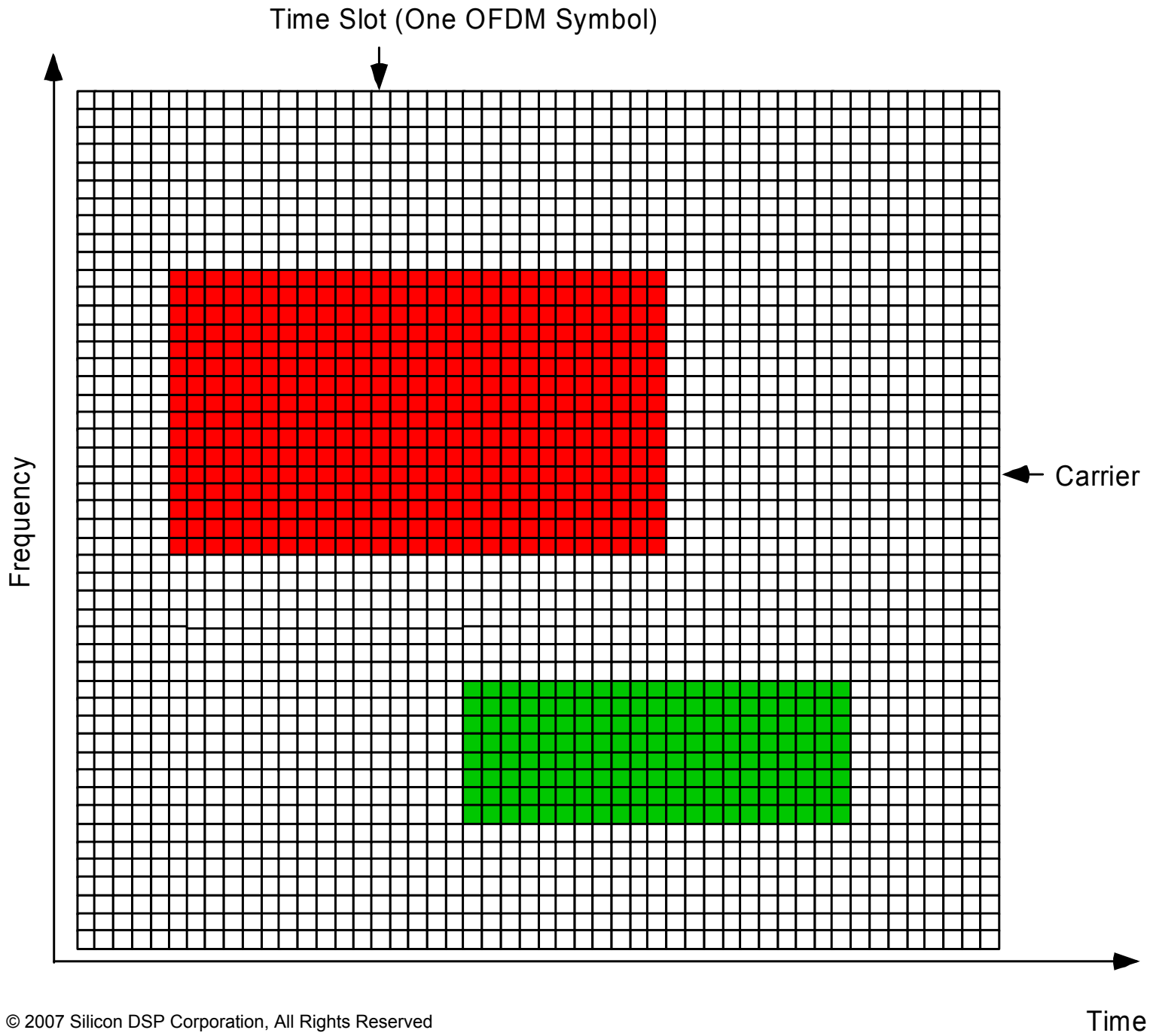

Time Slot (One OFDM Symbol)

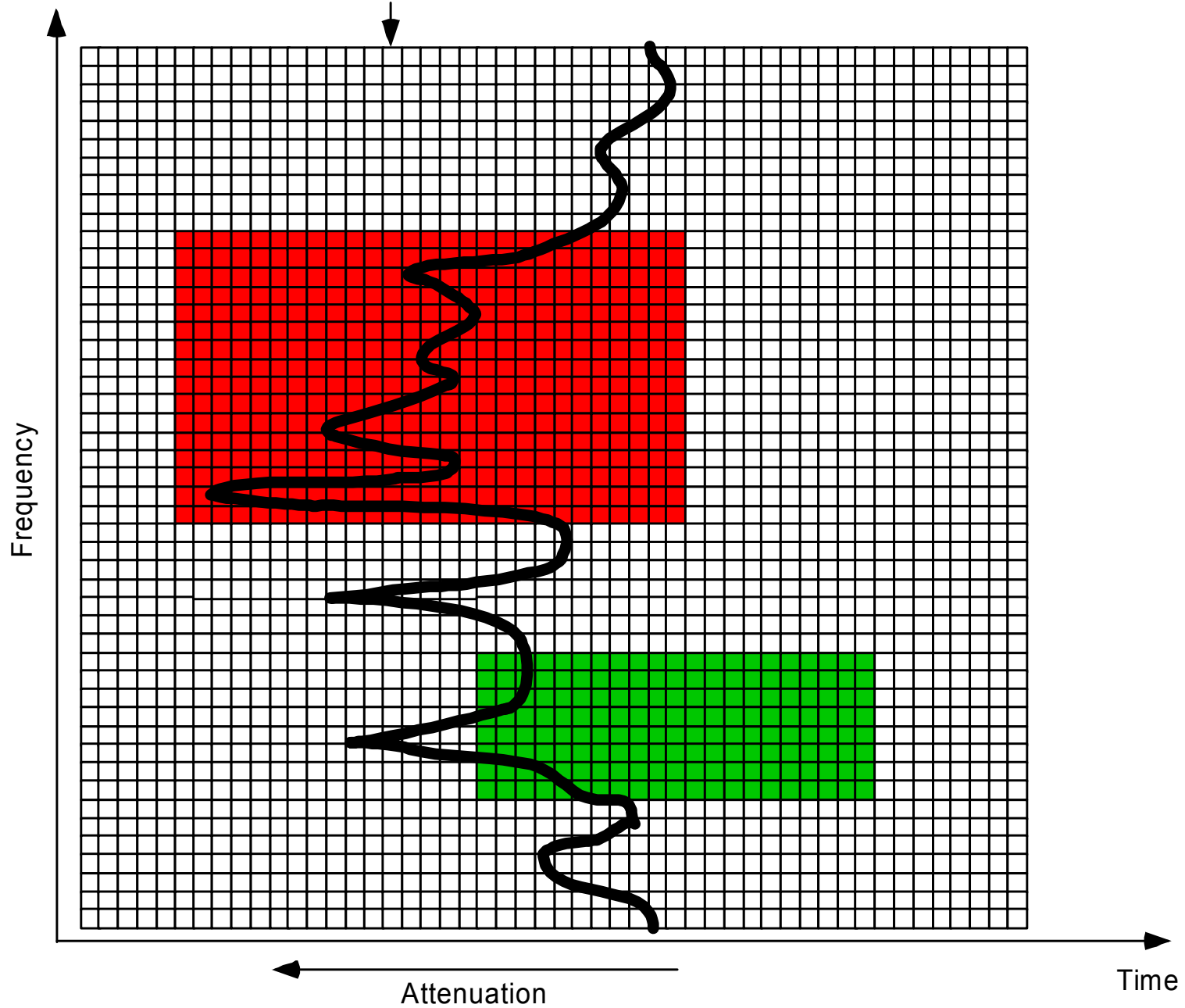

IEEE 802.16a OFDMA Carriers

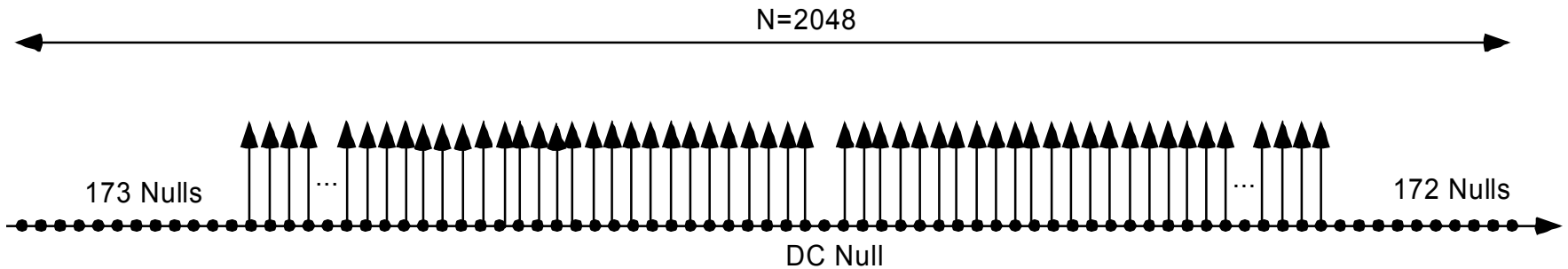

$N_{subchannels}$	32
$N_{subcarriers}$	48

N_{used}	1702
Number of Data Carriers	1536
Number of Pilots	166

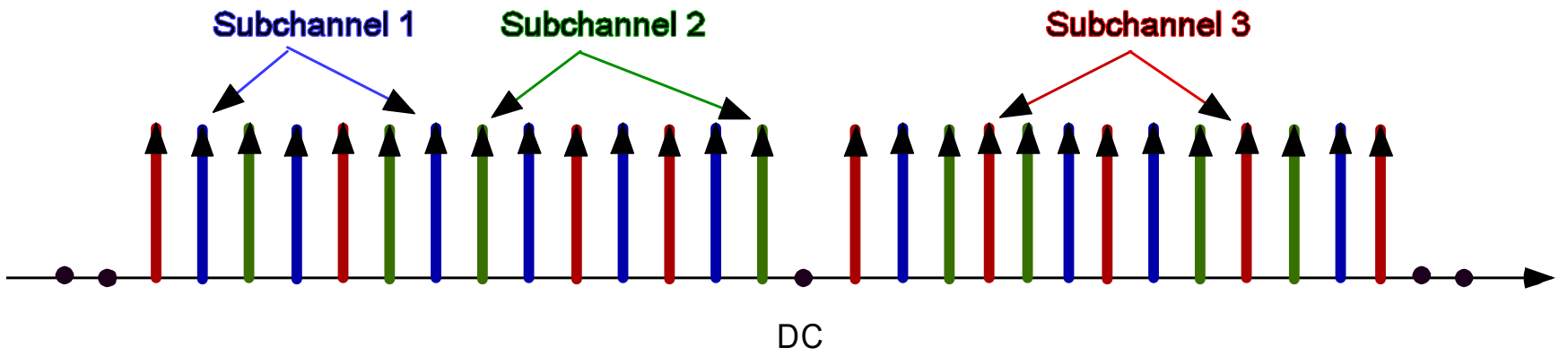

Partitioning of Data Carriers into Subchannels (DL)

$$carrier(n, s) = N_{subchannels} \cdot n + \{p_s[n_{mod(N_{subchannels})}]\} + ID_{cell} \cdot \{ceil[(n+1)/N_{subchannels}]\}_{mod(N_{subchannels})}$$

$\{PermutationBase_0\}$ {3, 18, 2, 8, 16, 10, 11, 15, 26, 22, 6, 9, 27, 20, 25, 1, 29,
7, 21, 5, 28, 31, 23, 17, 4, 24, 0, 13, 12, 19, 14, 30}

s is the index number of a subchannel, from the set $[0..N_{(subchannel)s}-1]$

n is the carrier-in-subchannel index from the set $[0..N_{subcarriers}-1]$

$carrier(n, s)$ is the carrier index of carrier n in subchannel s

$$ID_{Cell}=2$$

$$\text{Subchannel} = 2$$

n	Carrier	n	Carrier
0	18	24	782
1	44	25	821
2	77	26	848
3	113	27	864
4	156	28	901
5	184	29	948
6	200	30	964
7	235	31	1002
8	285	32	1044
9	310	33	1070
10	347	34	1103
11	355	35	1139
12	415	36	1182
13	425	37	1210
14	471	38	1226
15	487	39	1261
16	542	40	1311
17	545	41	1336
18	601	42	1373
19	627	43	1381
20	646	44	1409
21	698	45	1451
22	706	46	1497
23	751	47	1513

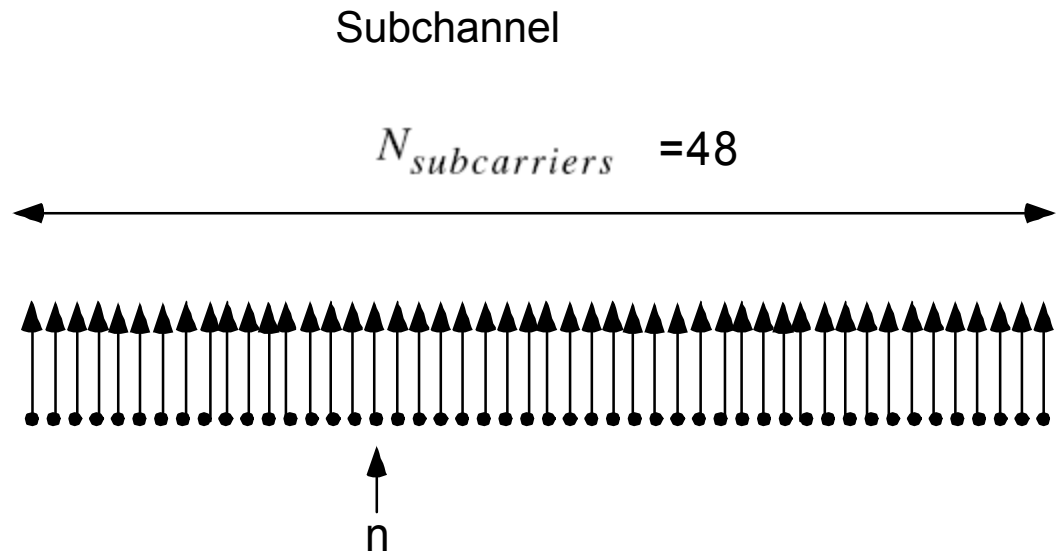

OFDMA Symbol Index

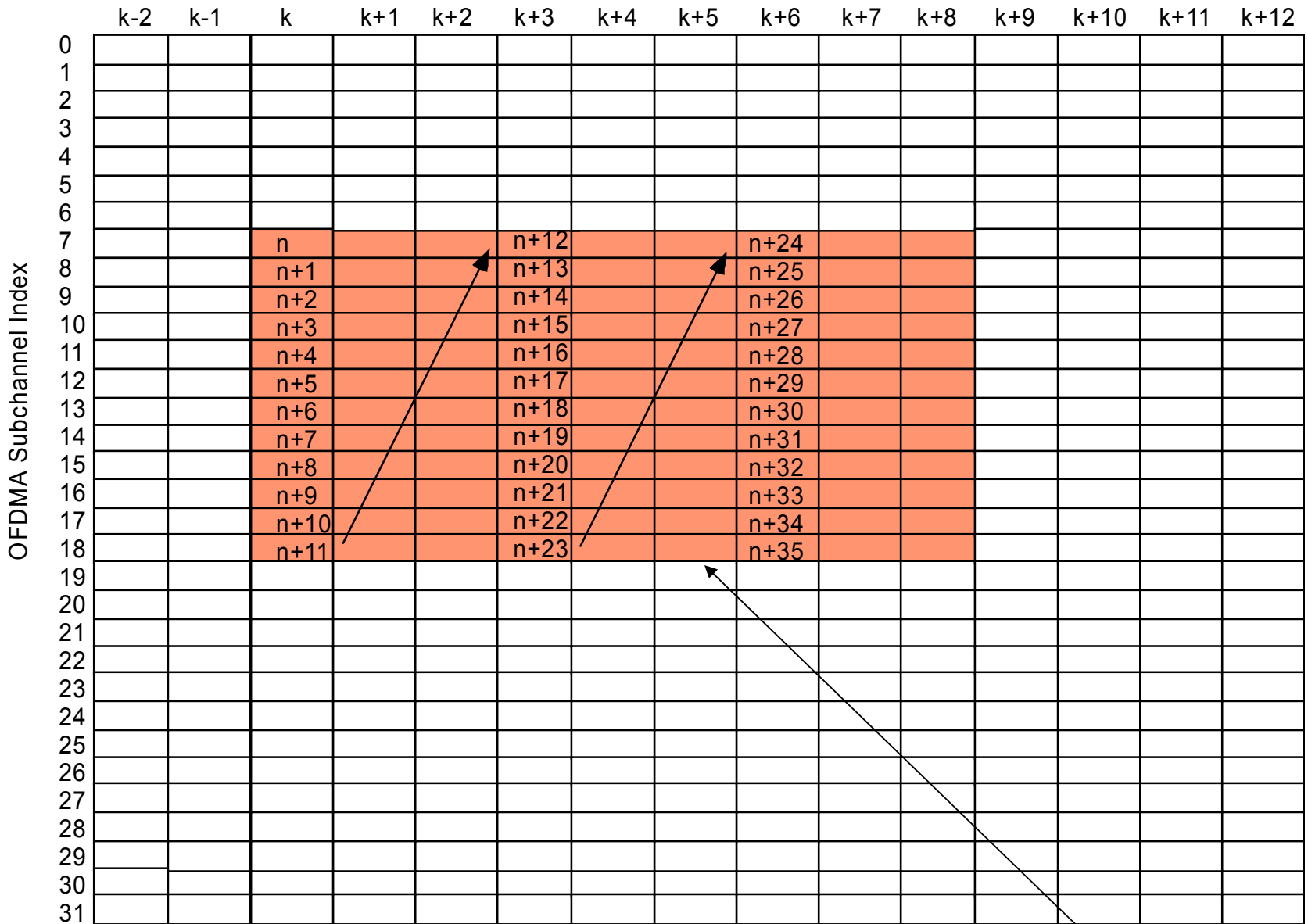

Numbers $n, n+1, n+2, \dots$ in the boxes indicate indices on FEC blocks which are transmitted on the indicated subchannel in the indicated symbol.

Data Region

Sub-Channels

- Active carriers are divided into subsets of carriers
- $N_{\text{FFT}}=2048$
- Each subset is termed a **subchannel**.
- In the DL, a **subchannel** may be intended for different (groups of) receivers.
- In the UL, a transmitter may be assigned one or more **subchannels**, several transmitters may transmit in parallel.
- The carriers forming one subchannel may, but need not be adjacent.

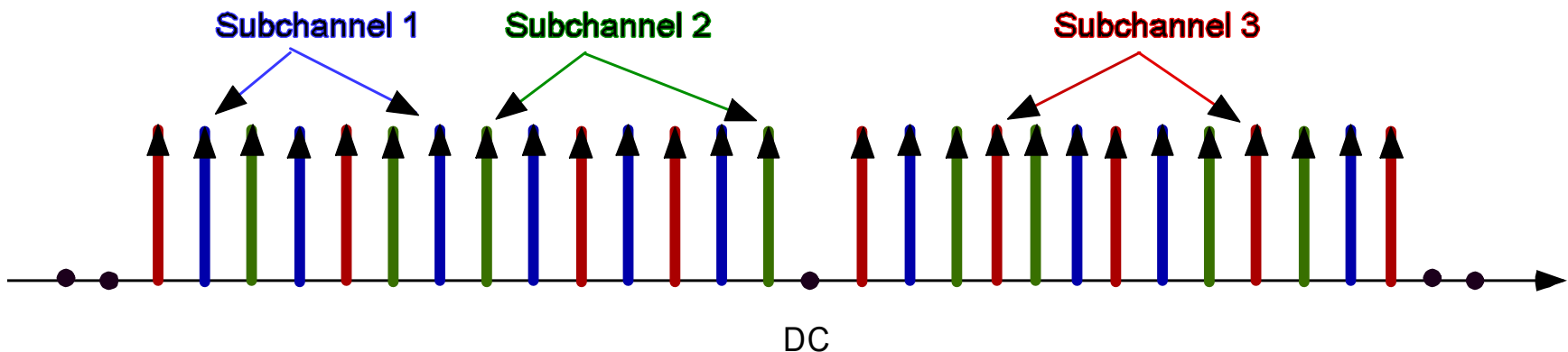

Table 116ca—OFDMA DL carrier allocations

Parameter	Value
Number of dc carriers	1
Number of guard carriers, left	173
Number of guard carriers, right	172
N_{used} , Number of used carriers	1702
Total number of carriers	2048
$N_{varLocPilots}$	142
Number of fixed-location pilots	32
Number of variable-location pilots which coincide with fixed-location pilots	8
Total number of pilots ^a	166
Number of data carriers	1536
$N_{subchannels}$	32
$N_{subcarriers}$	48
Number of data carriers per subchannel	48
BasicFixedLocationPilots	{0,39, 261, 330, 342, 351, 522, 636, 645, 651, 708, 726, 756, 792, 849, 855, 918, 1017, 1143, 1155, 1158, 1185, 1206, 1260, 1407, 1419,1428, 1461, 1530,1545, 1572, 1701}
$\{PermutationBase_0\}$	{3, 18, 2, 8, 16, 10, 11, 15, 26, 22, 6, 9, 27, 20, 25, 1, 29, 7, 21, 5, 28, 31, 23, 17, 4, 24, 0, 13, 12, 19, 14, 30}

^aVariable Location Pilots which coincide with Fixed-location Pilots are counted only once in this value.

16a OFDMA Carrier Allocations

- $N_{\text{used}} = N_{\text{FFT}}$ minus DC and Guard Carriers
- For UL and DL used carriers are: allocated pilots and data carriers.
- In DL pilot tones are allocated first, remaining carriers are subchannels used exclusively for Data
- In UL the set of used carriers are partitioned into subchannels and then the pilot carriers are allocated within each subchannel.
- In DL there is one set of common pilot carriers.
- In UL each subchannel contains its own set of pilot carriers.
- Why, because the BS DL is broadcast to all SS's, but in UL, each subchannel may be transmitted from a different SS (to BS).

Uplink Transmitters

SS's

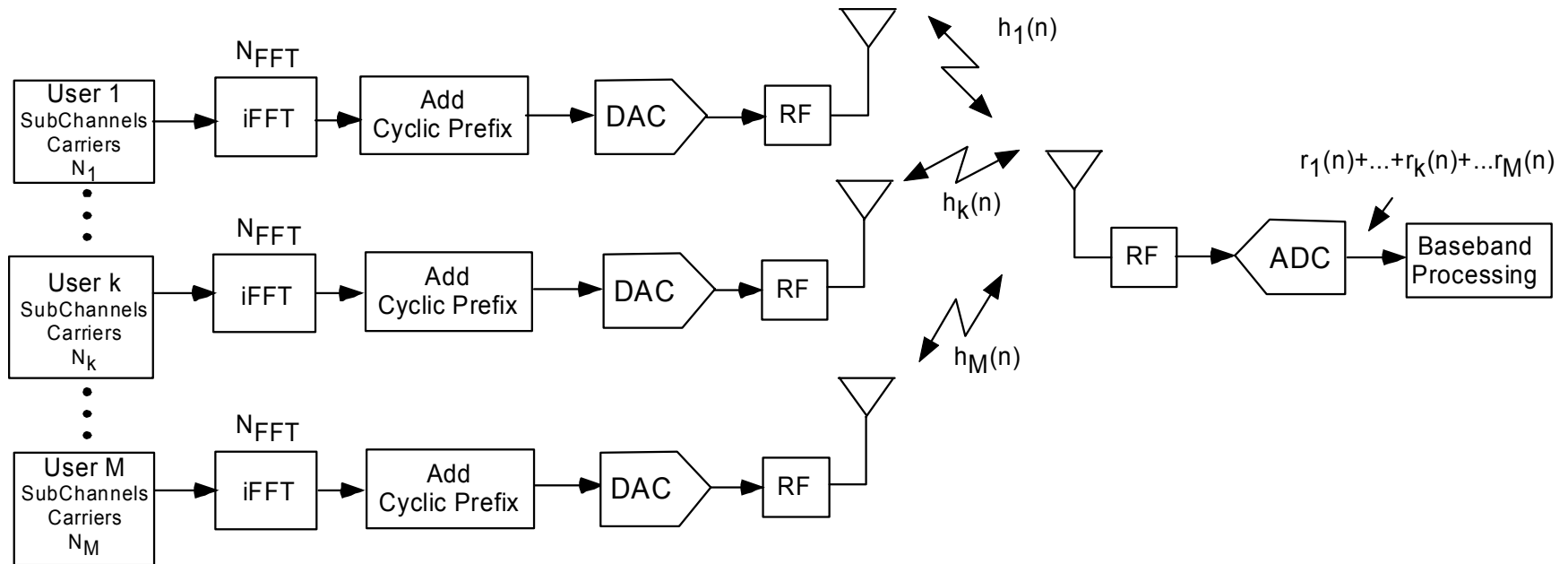

$$N_1 + \dots + N_k + \dots + N_M < N_{\text{FFT}}$$

Adapted with modifications from:

S. Manohar, V. Tikiya, D. Sreedhar, and A. Chockalingam
 "A Multiuser Interference Cancellation Scheme for Uplink OFDMA",
 Department of ECE, Indian Institute of Science, Bangalore 560012, INDIA, 2006 IEEE



Downlink Map (DL-MAP) message

802.16

6.2.2.3.2 Downlink Map (DL-MAP) message

The DL-MAP message defines the access to the downlink information. If the length of the DL-MAP message is a nonintegral number of bytes, the LEN field in the MAC header is rounded up to the next integral number of bytes. The message shall be padded to match this length, but the SS shall disregard the 4 pad bits.

A BS shall generate DL-MAP messages in the format shown in Table 15, including all of the following parameters:

PHY Synchronization

The PHY synchronization field is dependent on the PHY specification used. The encoding of this field is given in each PHY specification separately.

DCD Count

Matches the value of the configuration change count of the DCD, which describes the down burst profiles that apply to this map.

Base Station ID

The Base Station ID is a 48-bit long field identifying the BS. The Base Station ID shall be programmable. The most significant 24 bits shall be used as the operator ID. This is a network management hook that can be combined with the Downlink Channel ID of the DCD message for handling edge-of-sector and edge-of-cell situations.

Number of Elements

The number of information elements that follows.

The encoding of the remaining portions of the DL-MAP message is PHY-specification dependent and may be absent. Refer to the appropriate PHY specification.

OFDMA Symbol Number

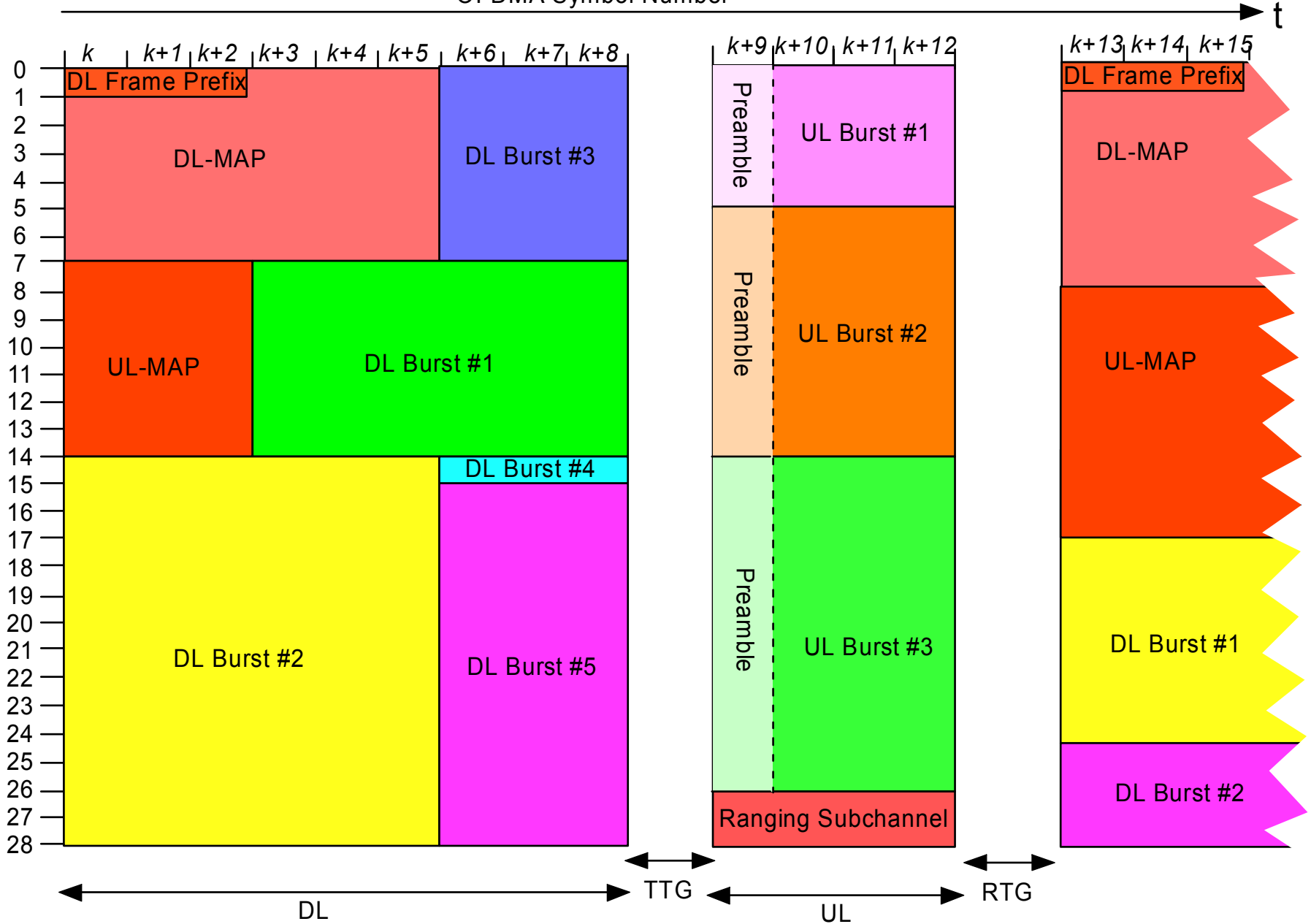

Downlink

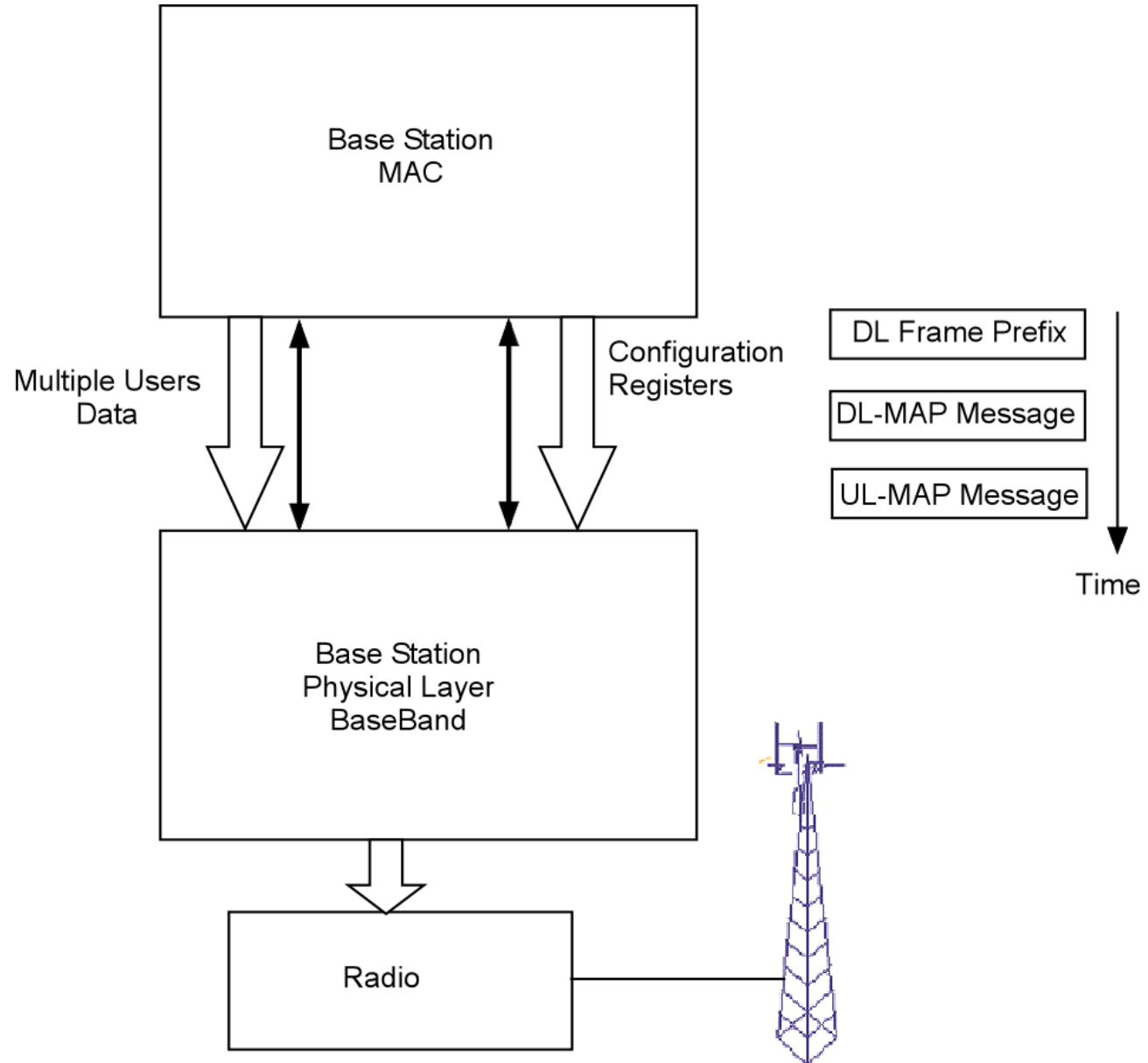

OFDMA Symbol Number

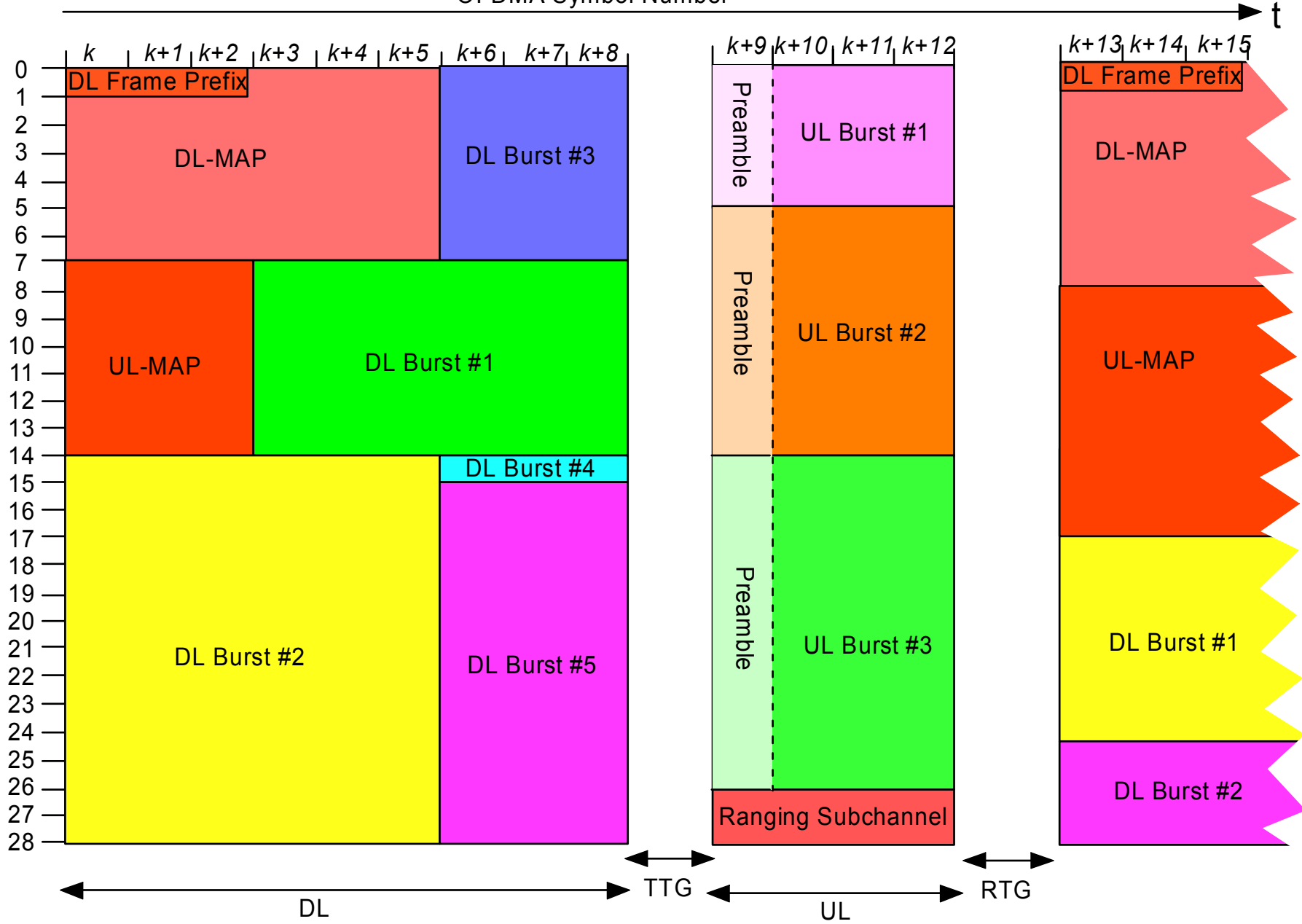

Table 116bm—OFDMA DL Frame Prefix

Syntax	Size	Notes
DL_Frame_Prefix_Format() {		
Rate_ID	4 bits	
Reserved	4 bits	
DL_Information_Message_Rectangle() {		
No_OFDM_Symbols	10 bits	
No_subchannels	6 bits	
}		
Prefix_CS	8 bits	
}		

← Max 32

Table 116ao—OFDM Rate ID encodings

Rate_ID	Modulation RS-CC rate
0	QPSK 1/2
1	QPSK 3/4
2	16-QAM 1/2
3	16-QAM 3/4
4	64-QAM 2/3
5	64-QAM 3/4
6–15	Reserved



Figure 128aw—Structure of the first FEC block in OFDMA

DL-MAP Message Format

Table 15—DL-MAP message format

Syntax	Size	Notes
DL-MAP_Message_Format() {		
Management Message Type = 2	8 bits	
PHY Synchronization Field	Variable	See appropriate PHY specification.
DCD Count	8 bits	
Base Station ID	48 bits	
Number of DL-MAP Elements n	16 bits	
Begin PHY Specific Section {		See applicable PHY section.
for ($i = 1; i \leq n; i++$) {		For each DL-MAP element 1 to n .
DL_MAP_Information_Element()	Variable	See corresponding PHY specification.
if !(byte boundary) {		
Padding Nibble	4 bits	Padding to reach byte boundary.
}		
}		
}		
}		

OFDMA DL-MAP Information Element Format

Table 116bp—OFDMA DL-MAP_Information_Element format

Syntax	Size	Notes
DL-MAP_Information_Element() {		
DIUC	4 bits	
if(UIUC == 15) {		
Extended DIUC dependent IE	variable	AAS_DL_IE()
} else {		
OFDM Symbol offset	10 bits	
Subchannel offset	6 bits	
No. OFDM Symbols	10 bits	
No. Subchannels	6 bits	
}		
}		

OFDMA Symbol Number

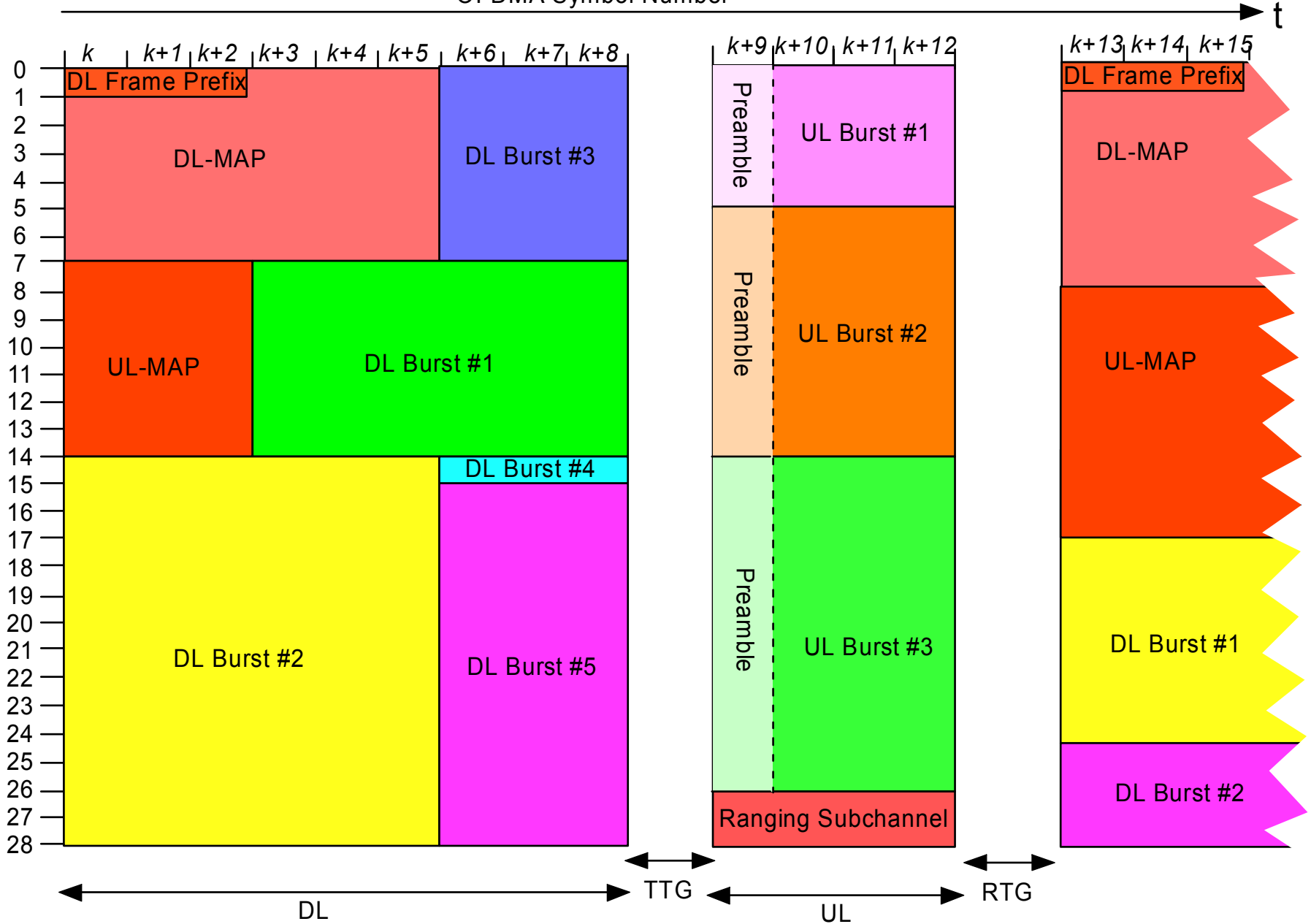

UL-MAP Message Format

Table 17—UL-MAP message format

Syntax	Size	Notes
UL-MAP_Message_Format() {		
Management Message Type = 3	8 bits	
Uplink Channel ID	8 bits	
UCD Count	8 bits	
Number of UL-MAP Elements n	16 bits	
Allocation Start Time	32 bits	
Begin PHY Specific Section {		See applicable PHY section.
for ($i = 1; i \leq n; i++$) {		For each UL-MAP element 1 to n .
UL_MAP_Information_Element()	Variable	See corresponding PHY specification.
}		
}		
}		

OFDMA UL-MAP Information Element Format

Table 116bt—OFDMA UL-MAP Information Element format

Syntax	Size	Notes
UL-MAP_Information_Element() {		
CID	16 bits	
UIUC	4 bits	
if (UIUC == 4) {		
CDMA_Allocation_IE()	52 bits	
else if (UIUC == 15) {		
Extended UIUC dependent IE	variable	Power_Control_IE() or AAS_UL_IE()
} else {		
OFDM Symbol offset	9 bits	
Subchannel offset	5 bits	
Boosting	2 bits	00: normal (not boosted); 01: +6dB; 10: -6dB; 11: not used.
No. OFDM Symbols	9 bits	
No. Subchannels	5 bits	
Reserved	2 bits	
}		
}		

OFDMA Symbol Number

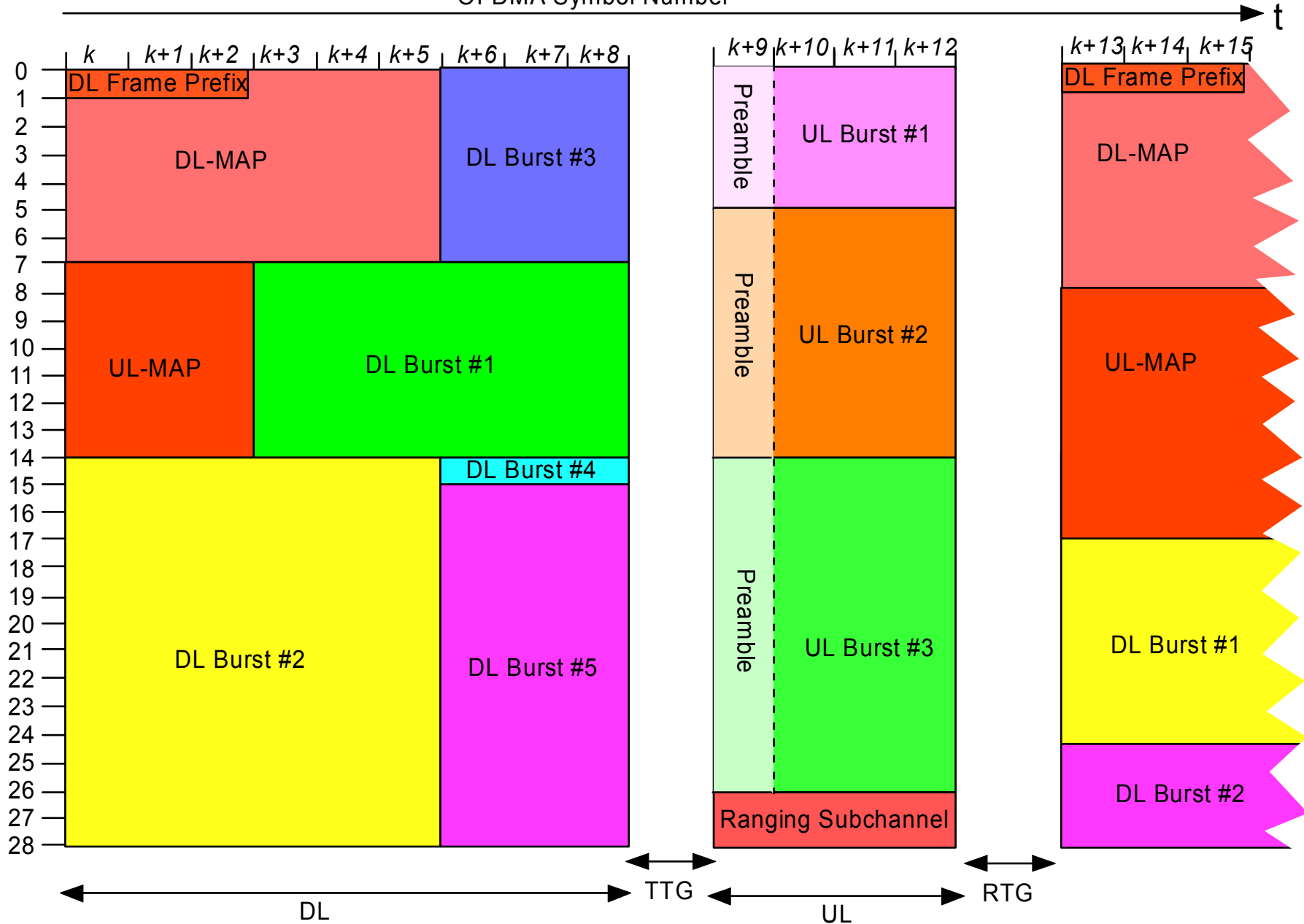

Uplink Interval Usage Code

Table 116bu—OFDMA UIUC values

UIUC	Usage
0	Reserved
1–9	Different burst profiles
10	Null Information Element
11	BW request, periodic ranging
12	Initial ranging
13	Reserved
14	CDMA Allocation Information Element
15	Extended UIUC

CDMA Allocation IE Format

Table 116bv—CDMA Allocation Information Element format

Syntax	Size	Notes
CDMA_Allocation_IE() {		
Ranging Code	6 bits	
Ranging Symbol	10 bits	
OFDM Symbol offset	8 bits	
Subchannel offset	6 bits	
No. OFDM Symbols	6 bits	
No. Subchannels	6 bits	
Ranging subchannel	6 bits	
BW request mandatory	1 bit	1= yes, 0= no
Reserved	3 bits	
}		

Ranging

In OFDMA it is required that all transmissions from various mobile subscriber station (MSS) should arrive at the base station (BS) at the same time.

During start of initial ranging (process of establishing synchronization), the timing offset between the mobile subscriber station (MSS) and the base station (BS) is more than the round trip delay (RTD), which is quite high and additionally, the system may have frequency offsets. Another challenge is that the MSS does not know what power level is to be used for transmission. It starts transmitting with the least power and waits for a response from the BS; if the BS has received the transmission from the MSS then it transmits back a ranging response to the MSS. If the transmission is lost then the MSS restarts the ranging process at a higher power level, which increases interference. In OFDMA system [7], we use code division multiple access (CDMA) codes to improve the system efficiency in detecting the new user. A new MSS will transmit this CDMA code, which the BS should detect.

The MSS's, which are distributed all over the cell, receive data at different instant of time and similarly transmit data at different instant of time depending on their distance from the BS. A MSS at the cell boundary receives data quite late and transmits data very early when compared with MSS close to the BS.

When a new MSS is seeking entry into the network, its distance, with reference to the BS, is not known hence the RTD is not known. The MSS does not have any idea as to what time or power should be used for transmitting the initial signal. This is the BS's job to detect this new MSS, find the misalignment between the new MSS and the network, and then send response, to correct it.

M Shakeel Baig , "Signal Processing Requirements for WiMAX (802.16e) Base Station", *Signal Processing Group, Department of Signals and Systems, Chalmers University of Technology, Göteborg, Sweden, 2005*

Initial Ranging

An OFDM system performance highly depends on synchronization between the transmitter and the receiver. When a new SS or MSS is trying to enter a network, it is not synchronized. Hence it tries to achieve coarse synchronization by listening to the transmissions from the BS, and then starts transmitting to achieve fine synchronization. The MSS starts transmission by the least possible power, each time increasing it by a level, if nothing is heard back from the BS. The BS is to detect the new MSS and calculate the time offset, frequency offset and power offset, then reply back to the MSS to correct its transmitting parameters before transmitting data. The process goes on (maximum 16 number of times) until the MSS has achieved synchronization. This process of obtaining synchronization and logging onto the network is known as initial ranging.

Cross-correlation in time domain

The CDMA code (defined in frequency domain) which is used for ranging is defined such that it has very good autocorrelation properties. This fact is harnessed in detection of the timing offset. The received signal in time domain is stored and cross-correlation is performed between the received signal and different predefined CDMA codes (to know which code was transmitted) in time domain. For the same code we get a correlation peak, index of which gives the time offset. In presence of multipath, we get many peaks corresponding to each multipath signal.

Ranging

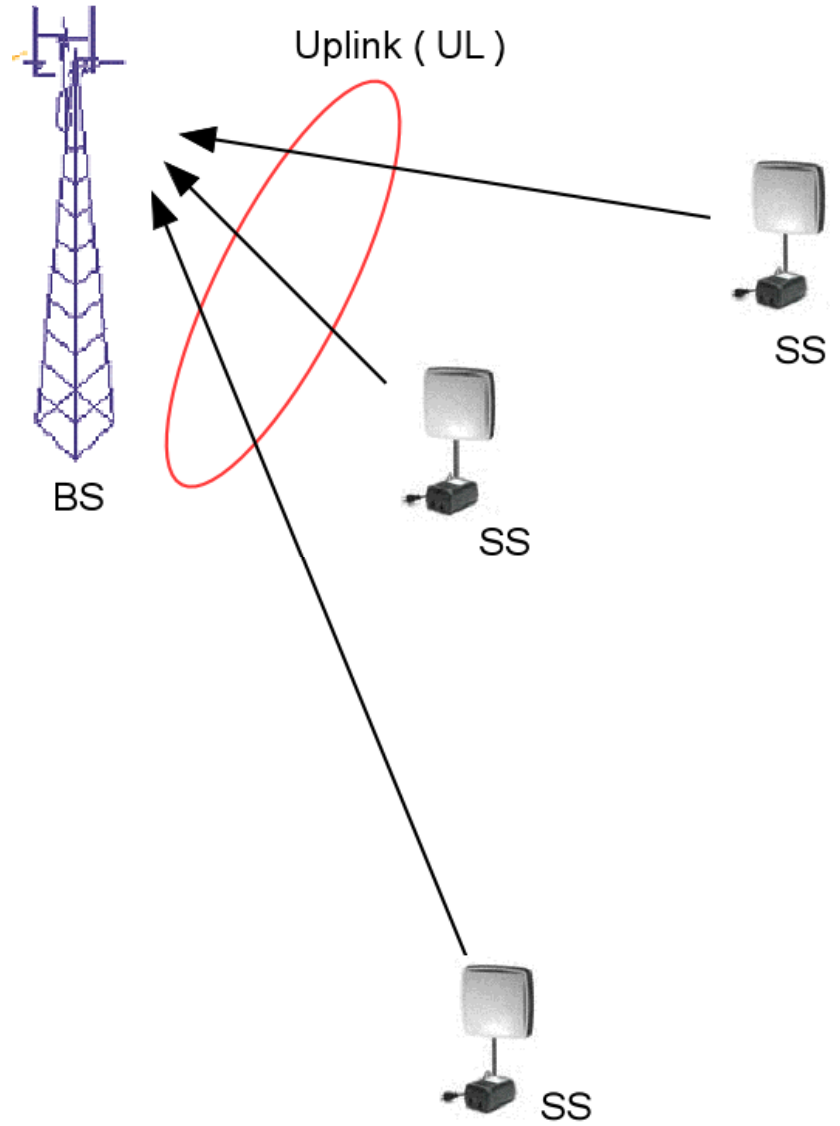
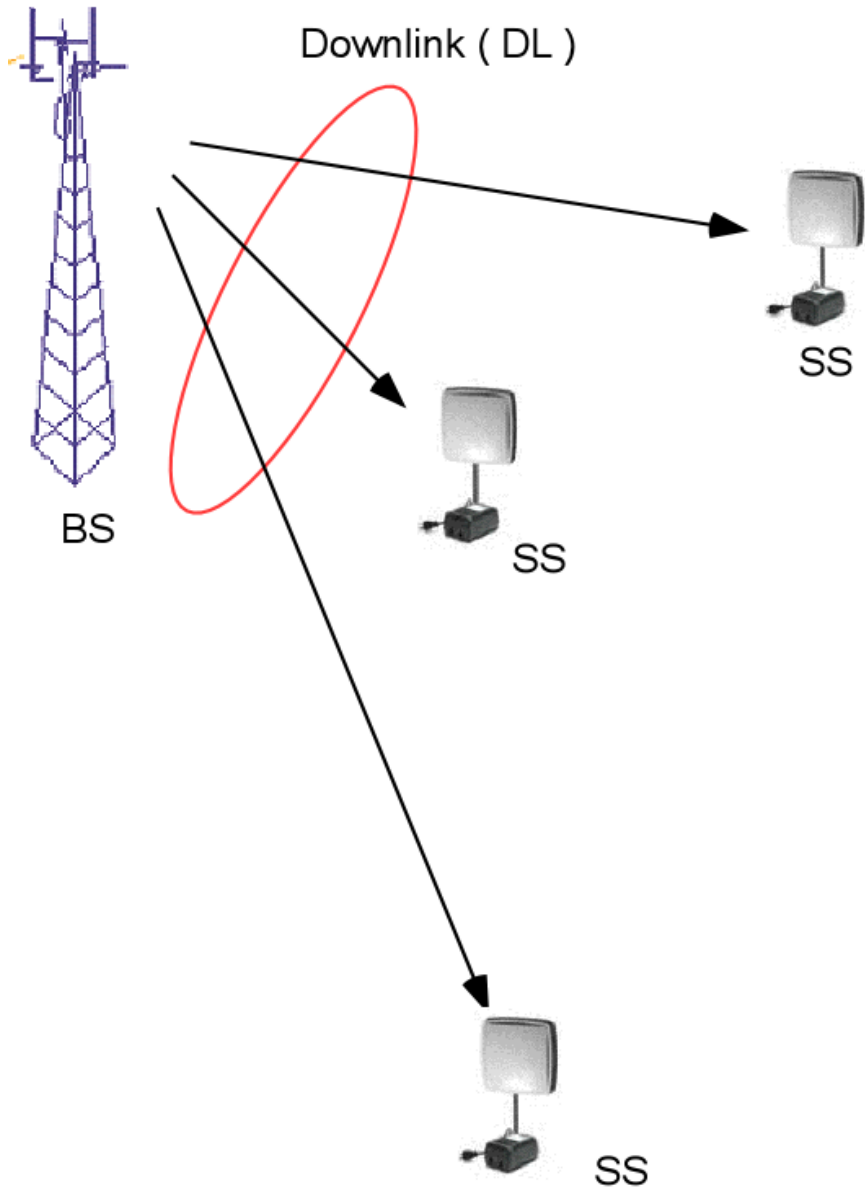

Example:

Symbol Time: 64 μsec

FFT Length: 2048

Sampling Rate 32 MHz

Cell Radius 20 km

Max Round Trip Delay RTD: 133 μsec

RTD from SSs can be anywhere up to 133 μsec .

Must process time window of 133+64 μsec .

This corresponds to 6304 complex samples.

CDMA code is 144 bits long in Frequency Domain.

Number of codes 256 (16e)

Using 2048 point FFT this corresponds to 2048 complex samples in the time domain.

Reference:

M SHAKEEL BAIG , "Signal Processing Requirements for WiMAX (802.16e) Base Station" *Signal Processing Group, Department of Signals and Systems, Chalmers University of Technology*

Cross Correlation Processing at BS

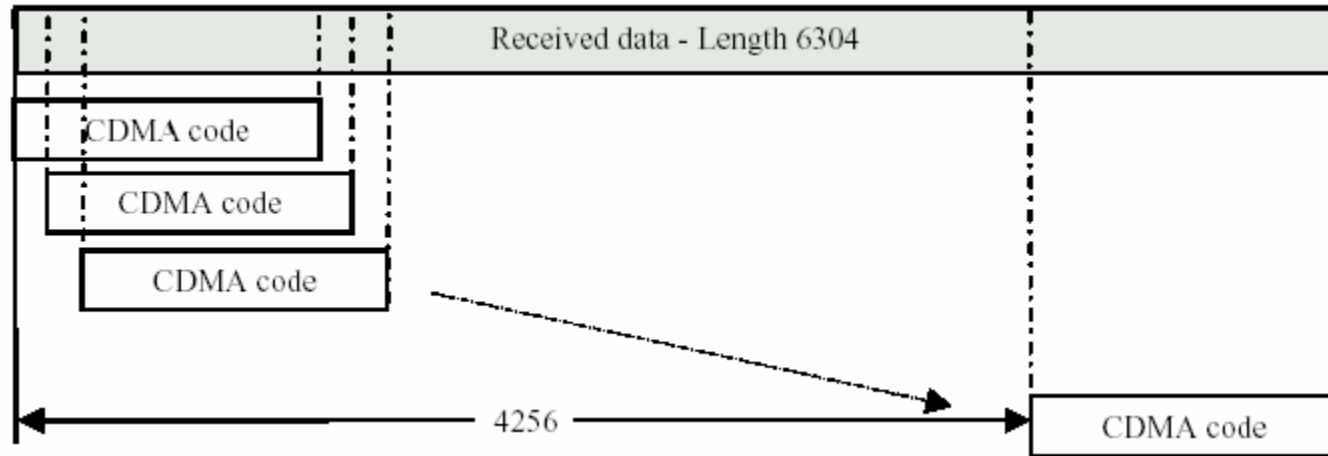

OFDMA Symbol Number

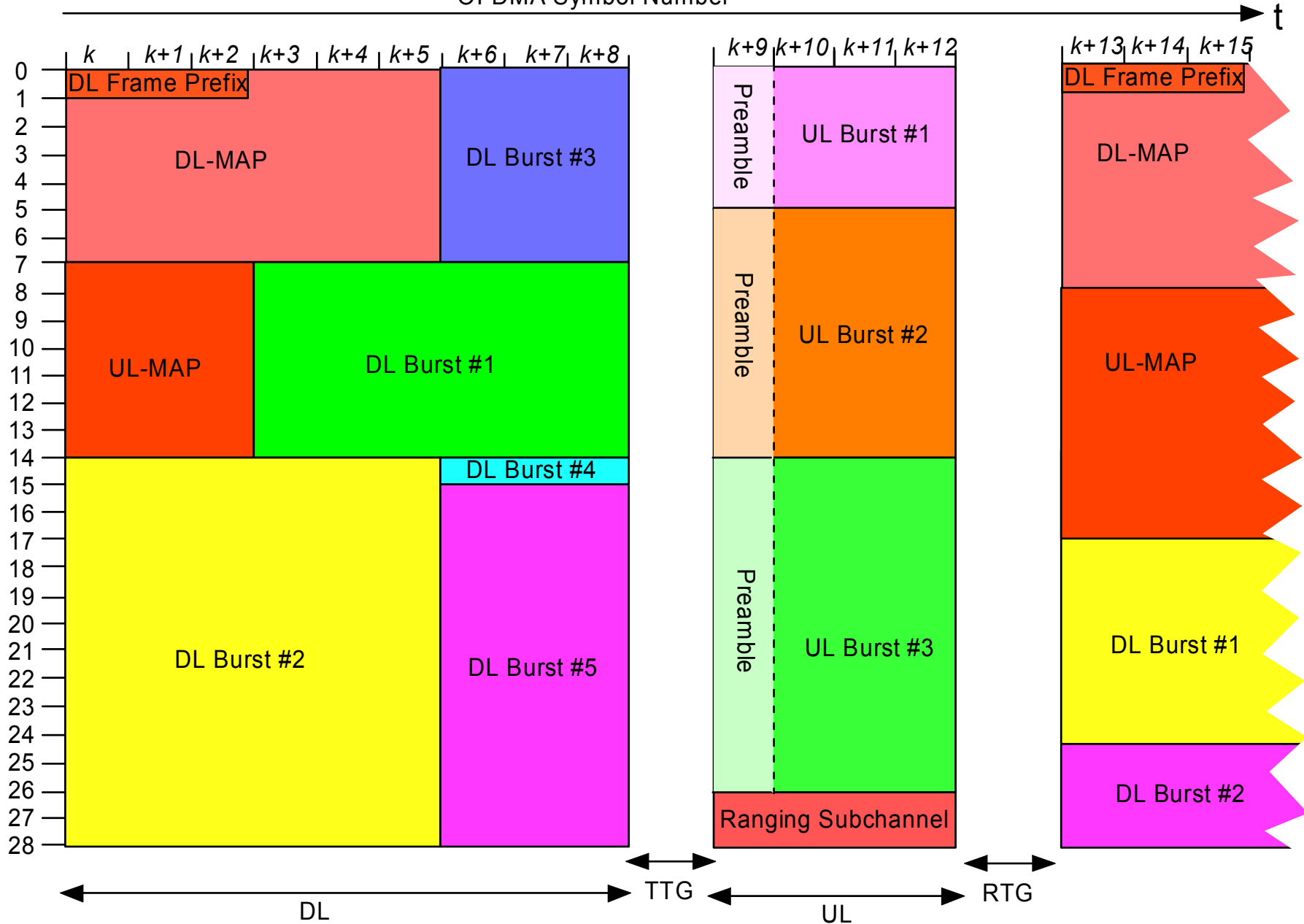

Ranging

- The SS, after acquiring downlink synchronization and uplink transmission parameters, shall **choose randomly** a Ranging Slot (with the use of a binary truncated exponent algorithm to avoid possible re-collisions) as the time to perform the ranging, then it chooses randomly a Ranging Code (from the Initial Ranging domain) and sends it to the BS (as a CDMA code).
- The BS **cannot tell which SS sent the CDMA ranging request**, therefore upon successfully receiving a CDMA Ranging Code, the BS broadcasts a Ranging Response message that **advertises the received Ranging Code as well as the ranging slot** (i.e., OFDM symbol number, subchannel, etc.) where the CDMA Ranging code has been identified. This information is used by the SS that sent the CDMA ranging code to identify the Ranging Response message that corresponds to its ranging request. The Ranging Response message contains all the needed adjustment (e.g., **time, power and possibly frequency corrections**) and a status notification.
- Upon receiving Ranging Response message with continue status, the SS shall continue the ranging process as done on the first entry with ranging codes randomly chosen from the Periodic Ranging domain.
- Using the OFDMA ranging mechanism, the periodic ranging timer is controlled by the SS, not the BS.

Ranging and Automatic Adjustments Procedure

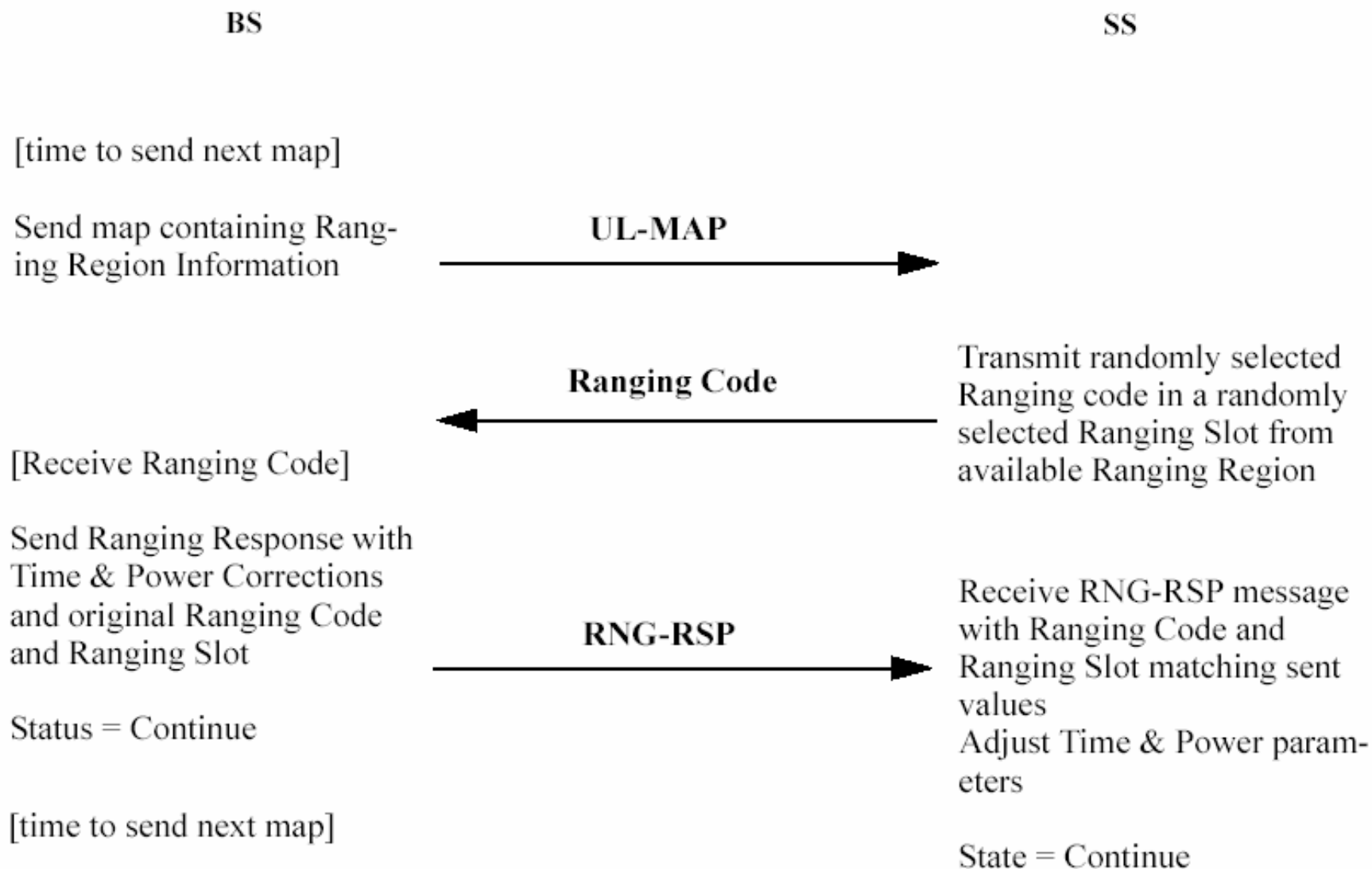

Ranging Continued

BS

SS

Send map containing Ranging Region Information

UL-MAP



Ranging Code



[Receive Ranging Code]

Send Ranging Response with Time & Power Corrections and original Ranging Code and Ranging Slot

RNG-RSP



Status = Success

Transmit randomly selected Ranging code in a randomly selected Ranging Slot from available Ranging Region

Receive RNG-RSP message with Ranging Code and Ranging Slot matching sent values

Adjust Time & Power parameters

State = Success

Table 116bv—CDMA Allocation Information Element format

Syntax	Size	Notes
CDMA_Allocation_IE() {		
Ranging Code	6 bits	
Ranging Symbol	10 bits	
OFDM Symbol offset	8 bits	
Subchannel offset	6 bits	
No. OFDM Symbols	6 bits	
No. Subchannels	6 bits	
Ranging subchannel	6 bits	
BW request mandatory	1 bit	1= yes, 0= no
Reserved	3 bits	
}		