

ADC Requirements

Permission is granted to copy, distribute and/or modify this document under the terms of the GNU Free Documentation License, Version 1.3 or any later version published by the Free Software Foundation; with no Invariant Sections, no Front-Cover Texts, and no Back-Cover Texts. A copy of the license is attached entitled "GNU Free Documentation License".



Silicon DSP Corporation

© 2007 Silicon DSP Corporation, All Rights Reserved

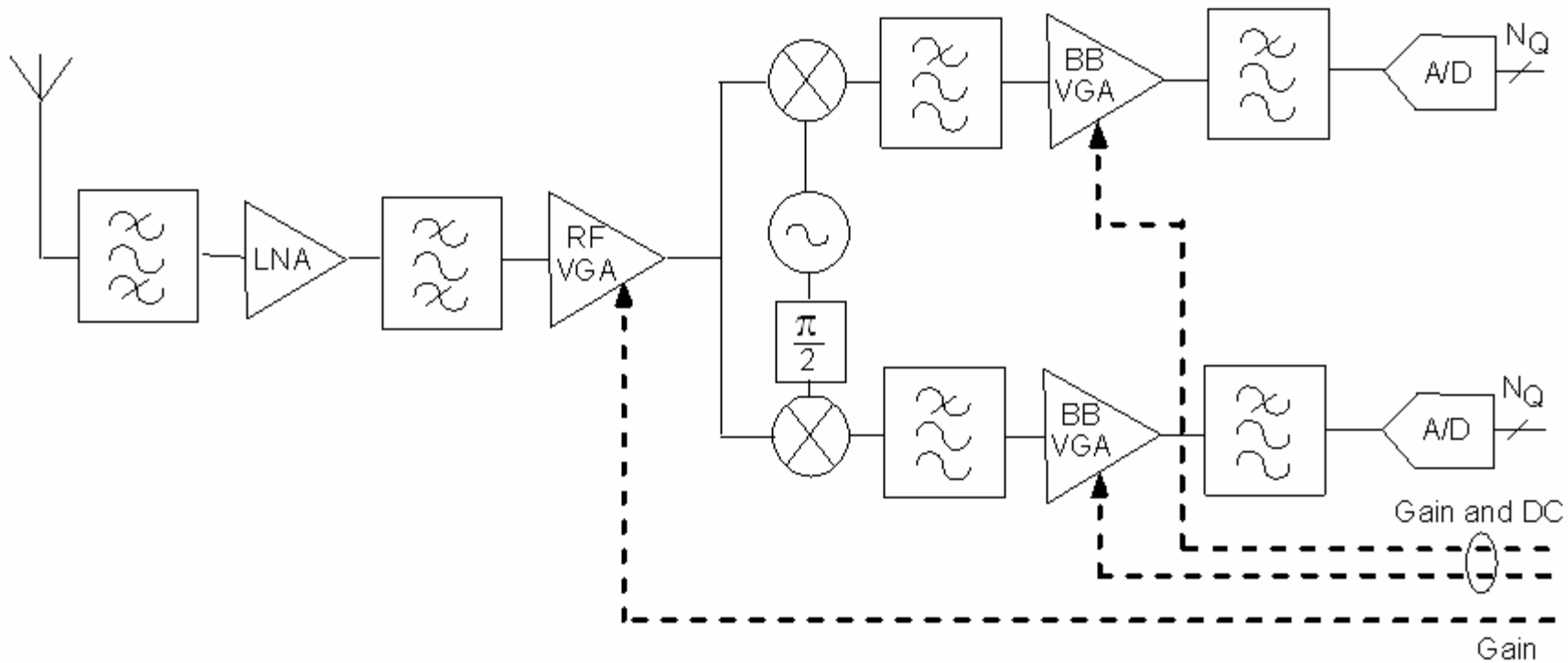

ADC

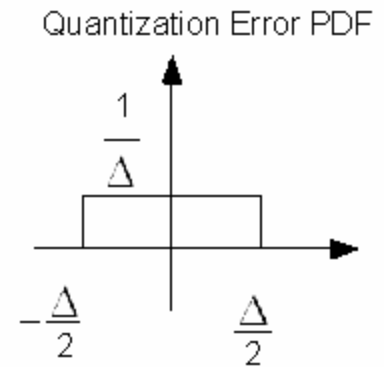
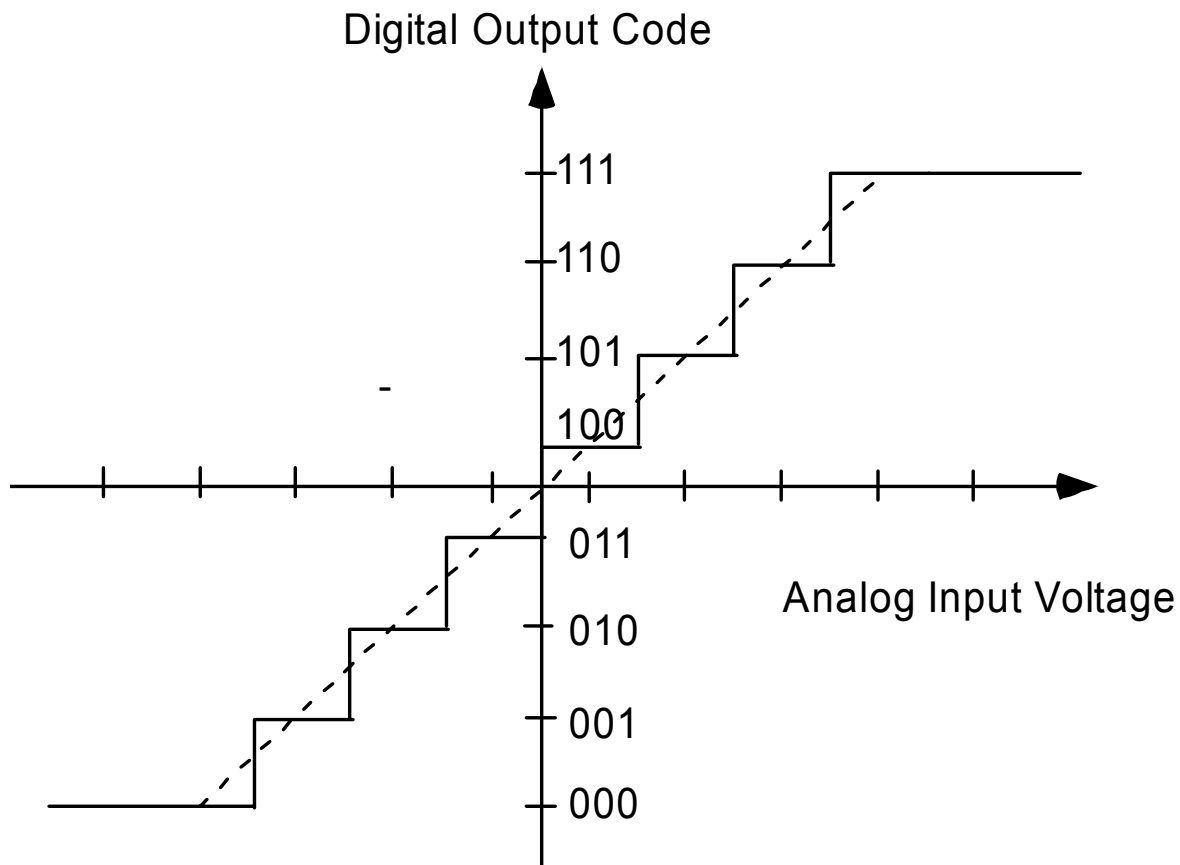

$$\sigma_q^2 = \frac{\Delta^2}{12}$$

Signal to Noise Ratio Sinusoidal Input



Digital Output Code

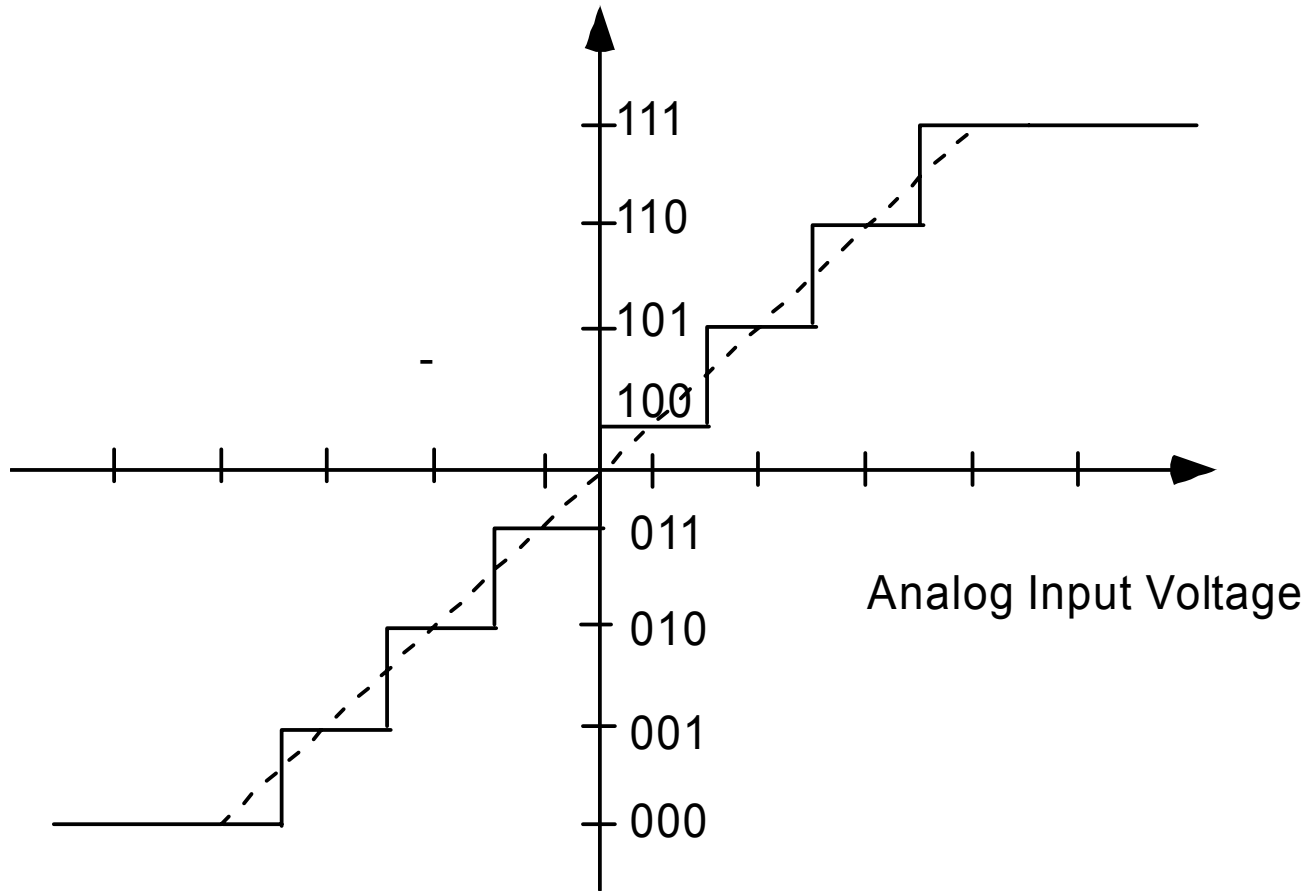

$$SNR_{\text{full scale}} = \frac{\left(\frac{FS}{2} \frac{1}{\sqrt{2}}\right)^2}{\sigma_q^2} = \frac{\left(\frac{2^n \Delta}{2} \frac{1}{\sqrt{2}}\right)^2}{\frac{\Delta^2}{12}} = 2^{2n} \frac{12}{8}$$

$$SNR_{\text{full scale}} = n20 \log_{10}(2) + 10 \log_{10}\left(\frac{12}{8}\right)$$

$$SNR_{\text{full scale}} = 6.02n + 1.76$$



SNR for Arbitrary Input

$$SNR = 6n + 4.76 - 20 \log_{10} \frac{\text{peak}}{\text{average}}$$

For sinusoid $\sigma_{\text{rms}} = \frac{A}{\sqrt{2}}$ so the peak to average ratio is $\sqrt{2}$ or 3dB.

$$SNR = 6n + 4.76 - 3$$

For OFDM the peak to average ratio is from 6 to 10 dB



ADC Dynamic Range

1. Difference between the maximum and minimum receivable signal strengths
2. AGC Step size
3. Ratio of in-channel noise/interference to quantization noise
4. Signal peak-to-average ratio
5. DC Offset
6. Upper and lower fading margin
7. Adjacent channel filtering suppression amount



Difference between the maximum and minimum receivable signal strengths

17.3.10.4 Receiver maximum input level

The receiver shall provide a maximum PER of 10% at a PSDU length of 1000 bytes, for a maximum input level of -30 dBm measured at the antenna for any baseband modulation.

Table 91 – Receiver performance requirements

Data rate (Mbits/s)	Minimum sensitivity (dBm)	Adjacent channel rejection (dB)	Alternate adjacent channel rejection (dB)
6	-82	16	32
9	-81	15	31
12	-79	13	29
18	-77	11	27
24	-74	8	24
36	-70	4	20
48	-66	0	16
54	-65	-1	15

Dynamic Range

$$-30\text{dBm} - (-82\text{dBm}) = 62 \text{ dB}$$



Ratio of in-channel noise/interference to quantization noise

This value depends on modulation and other factors.

Require that quantization noise to be 10 dB below in-channel-band noise at the minimum sensitivity point.

-65 dBm for 54 Mbps.

So for 54 Mbps required SNR is 24 dB. Then ADC Signal to Quantization noise is $34=24+10$ dB

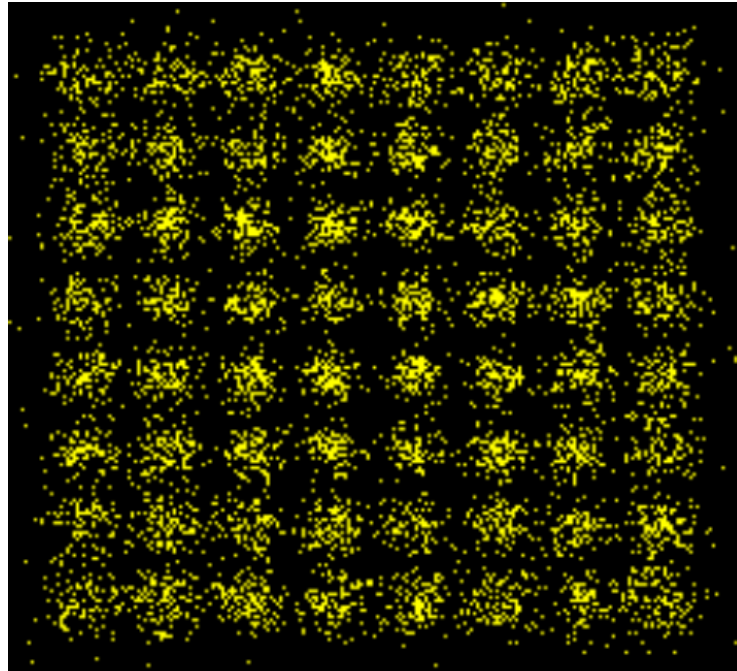

AGC Fading Characteristic

AGC done on Preamble.

Yet Data rms varies across many fading multipath realizations.

Must allow 5-7 dB for variation.

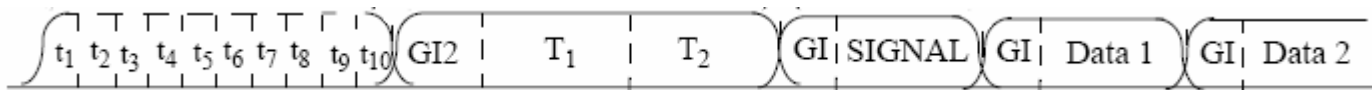
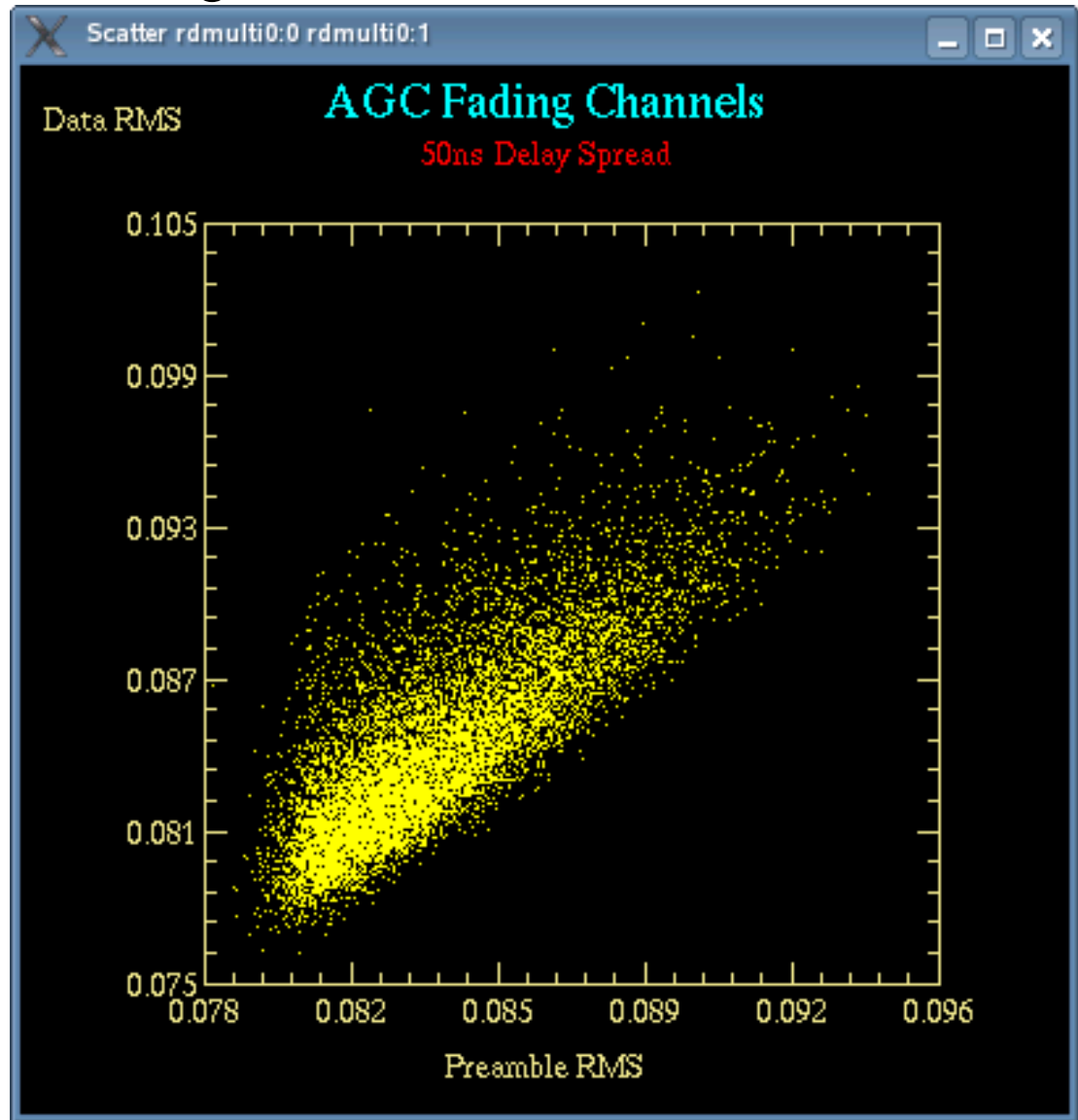

Adjacent Channel Filtering

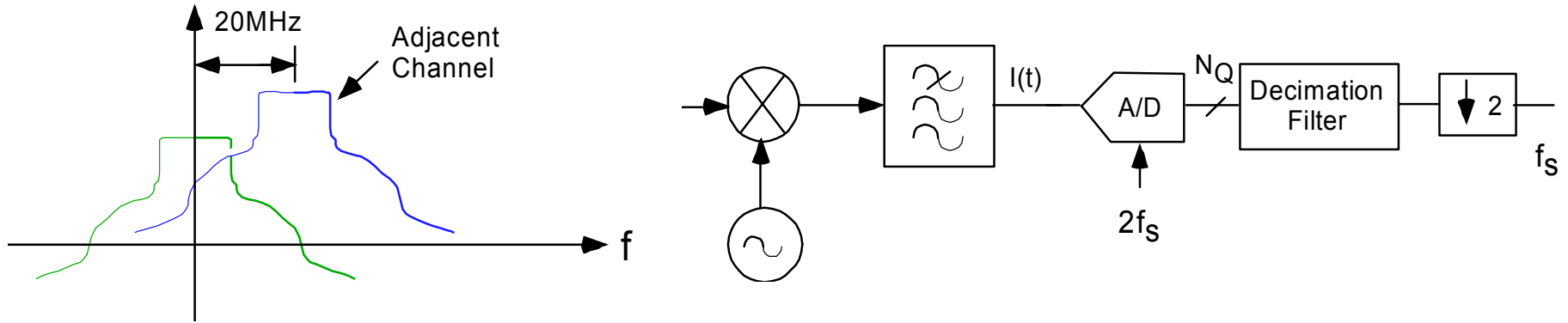

When Adjacent Channel present, most is filtered and suppressed by digital decimation filter **after** ADC.

But large jammer present due to relaxed filtering in analog front end.

So ADC will have large component due to adjacent channel which may be larger than desired signal.

Must allow for this. E.g. 6 dB.



AGC Algorithm

The ADC can absorb a wide range of the AGC by using more bits.

If AGC does a good job of mapping input signal range to target *rms* in ADC, still need to take into consideration enough dynamic range for fine AGC and AGC step size. Allow for 3-4 dB.



Total Number of Bits

AGC on Preamble Fading	5 dB
Adjacent Channel	6 dB
AGC (fine and stepping)	4 dB
SNR requirement	34=24 +10 dB
Peak to Average Ratio	10 dB
Total	59 dB, 9 Bits

$$SNR = 6n + 4.76 - 20 \log_{10} \frac{\text{peak}}{\text{average}}$$

This is close to published ADC specifications in the literature.

